



CO₂ Copper Fittings

TECHNICAL SPECIFICATIONS SUBMITTAL FORM

Job Name:	Submittal Date:	Wholesaler:
Job Location:	Engineer/Architect:	Contractor:

Product Use:

Copper Fittings for use in CO₂ Refrigeration Applications.

Design and Features:

- NDL ensures copper quality content and strict adherence to meet or exceed ASME B16.22 standards for wall thickness.
- Our high-pressure copper-iron alloy fittings are tested for actual burst pressure with the results exceeding 3 times the design pressure.
- Each fitting is marked with "CO₂ 130 BAR" and OD size for easy field identification.
- Fittings are poly-bagged within the box, keeping them clean and contaminant-free prior to installation.
- The fittings have tight tolerances on the cup side for a stronger joint with the tube and easier brazing.
- Our 1-Year Warranty proves that we have confidence in our fittings, and that they can be trusted in the field.
- Our copper fittings have zero reported failures since 1999.

Certifications and Approvals:

- UL Listed

Technical Data

SIZE RANGE	From 3/8" up to 2 1/8"
MATERIAL	Copper alloy CuFe2P C19400
OPERATING TEMPERATURE	-196° C to 150° C / -320° F to 302° F
BURST PRESSURE	>390 bar / >39 MPa / >5656 psi
MAXIMUM OPERATING PRESSURE	130 bar / 13 MPa / 1885 psi at 150° C
APPLICATION	Air conditioning and refrigeration. Designed for high-pressure applications, especially for CO ₂ (R744) systems.
TUBE COMPATIBILITY	Compatible with main pipe types manufactured from copper iron alloys available on the market.





Reducing Bushings

Reducing Bushings Dimensions and Selection

PART #	OD - DESCRIPTION	BOX QTY	T1 (IN)	T2 (IN)	L1 (IN)	WT (LB)	WT (G)
CO1312	1/2" x 3/8" Reducing Bushing	100	0.035"	0.550"	0.965"	0.017	7.50
CO21313	1/2" x 12mm Reducing Bushing	100	0.035"	0.026"	1.063"	0.019	8.50
CO1315	5/8" x 1/2" Reducing Bushing	100	0.041"	0.026"	1.103"	0.026	12.00
CO1317	5/8" x 3/8" Reducing Bushing	100	0.041"	0.022"	1.063"	0.026	12.00
CO1320	3/4" x 5/8" Reducing Bushing	100	0.053"	0.031"	1.240"	0.049	22.00
CO1321	3/4" x 1/2" Reducing Bushing	100	0.053"	0.026"	1.181"	0.046	21.00
CO1322	3/4" x 3/8" Reducing Bushing	100	0.053"	0.022"	1.280"	0.046	21.00
CO1328	7/8" x 3/8" Reducing Bushing	100	0.059"	0.022"	1.417"	0.068	31.00
CO1327	7/8" x 1/2" Reducing Bushing	100	0.059"	0.026"	1.398"	0.068	31.00
CO1326	7/8" x 5/8" Reducing Bushing	100	0.059"	0.031"	1.378"	0.066	30.00
CO1325	7/8" x 3/4" Reducing Bushing	100	0.059"	0.043"	1.457"	0.071	32.00
CO21326	7/8" x 22mm Reducing Bushing	100	0.059"	0.051"	1.693"	0.071	32.00
CO1340	1-1/8" x 1/2" Reducing Bushing	100	0.079"	0.026"	1.555"	0.117	53.00
CO1399	1-1/8" x 5/8" Reducing Bushing	30	0.079"	0.031"	1.594"	0.121	55.00
CO1338	1-1/8" x 3/4" Reducing Bushing	100	0.079"	0.043"	1.594"	0.123	56.00
CO1337	1-1/8" x 7/8" Reducing Bushing	100	0.079"	0.051"	1.693"	0.126	57.00
CO21338	1-1/8" x 28mm Reducing Bushing	100	0.079"	0.059"	1.811"	0.128	58.00
CO1347	1-3/8" x 5/8" Reducing Bushing	60	0.098"	0.031"	1.772"	0.176	80.00
CO1345	1-3/8" x 7/8" Reducing Bushing	60	0.098"	0.051"	1.850"	0.194	88.00
CO1343	1-3/8" x 1-1/8" Reducing Bushing	60	0.098"	0.059"	1.772"	0.203	92.00
CO21344	1-3/8" x 35mm Reducing Bushing	60	0.098"	0.079"	1.929"	0.220	100.00
CO1353	1-5/8" x 7/8" Reducing Bushing	30	0.110"	0.051"	2.087"	0.280	127.00
CO1351	1-5/8" x 1-1/8" Reducing Bushing	60	0.110"	0.059"	1.988"	0.282	128.00
CO1350	1-5/8" x 1-3/8" Reducing Bushing	60	0.110"	0.079"	1.909"	0.289	131.00
CO21349	1-5/8" x 42mm Reducing Bushing	30	0.110"	0.079"	2.087"	0.309	140.00
CO1362	2-1/8" x 7/8" Reducing Bushing	30	0.138"	0.051"	2.598"	0.606	275.00
CO1360	2-1/8" x 1-1/8" Reducing Bushing	30	0.138"	0.059"	2.480"	0.617	280.00
CO1359	2-1/8" x 1-3/8" Reducing Bushing	30	0.138"	0.079"	2.402"	0.639	290.00
CO1358	2-1/8" x 1-5/8" Reducing Bushing	30	0.138"	0.091"	2.343"	0.586	266.00

The information contained herein is not intended to replace the full product installation and safety information available or the experience of a trained product installer. You are required to thoroughly read all installation instructions and product safety information before beginning the installation of a product.

All installations must completely comply with all NDL Industries warnings and instructions, national state and local codes and all applicable ANSI standards.

NDL Industries product specifications in U.S. customary units and metric are approximate and are provided for reference only. For precise measurements, please contact Customer

Service. NDL Industries reserves the right to change or modify product design, construction, specifications, or materials without prior notice and without incurring any obligation to make such changes and modifications on NDL products previously or subsequently sold.

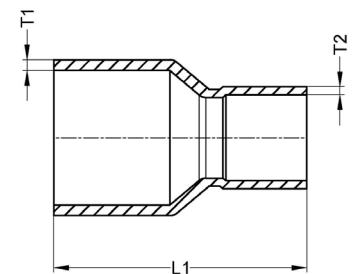

Explore our full line of high-quality HVAC-R, CO₂ Refrigeration, and Hydronic products.

ndlindustries.com | 1-866-635-6888 | sales@ndlinc.com

@ndlindustries





Caps Dimensions and Selection

	PART #	OD - DESCRIPTION	BOX QTY	T1 (IN)	L1 (IN)	WT (LB)	WT (G)
	CO7004	3/8" Cap	100	0.028"	0.472"	0.007	3.00
	CO7006	1/2" Cap	100	0.035"	0.591"	0.011	5.00
	CO7007	5/8" Cap	100	0.041"	0.709"	0.018	8.00
	CO7008	3/4" Cap	100	0.053"	0.787"	0.031	14.00
	CO7009	7/8" Cap	100	0.059"	1.024"	0.062	28.00
	CO7011	1-1/8" Cap	100	0.079"	1.102"	0.099	45.00
	CO7012	1-3/8" Cap	60	0.098"	1.299"	0.165	75.00
	CO7013	1-5/8" Cap	30	0.110"	1.417"	0.220	100.00
	CO7014	2-1/8" Cap	30	0.138"	1.811"	0.617	280.00

The information contained herein is not intended to replace the full product installation and safety information available or the experience of a trained product installer. You are required to thoroughly read all installation instructions and product safety information before beginning the installation of a product.

All installations must completely comply with all NDL Industries warnings and instructions, national state and local codes and all applicable ANSI standards.

NDL Industries product specifications in U.S. customary units and metric are approximate and are provided for reference only. For precise measurements, please contact Customer

Service. NDL Industries reserves the right to change or modify product design, construction, specifications, or materials without prior notice and without incurring any obligation to make such changes and modifications on NDL products previously or subsequently sold.

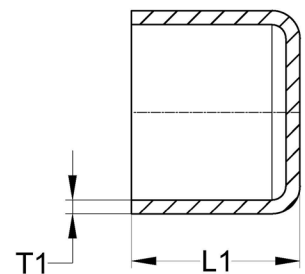

Explore our full line of high-quality HVAC-R, CO₂ Refrigeration, and Hydronic products.

ndlindustries.com | 1-866-635-6888 | sales@ndlinc.com

@ndlindustries





Reducing Couplings

Reducing Couplings Dimensions and Selection

PART #	OD - DESCRIPTION	BOX QTY	T1 (IN)	T2 (IN)	L1 (IN)	WT (LB)	WT (G)
CO1019	1/2" x 3/8" Reducing Coupling	100	0.035"	0.022"	1.004"	0.020	9.00
CO1023	5/8" x 1/2" Reducing Coupling	100	0.041"	0.026"	1.102"	0.031	14.00
CO1029	3/4" x 5/8" Reducing Coupling	100	0.053"	0.031"	1.299"	0.057	26.00
CO1035	7/8" x 3/4" Reducing Coupling	100	0.059"	0.043"	1.535"	0.086	39.00
CO1049	1-1/8" x 7/8" Reducing Coupling	100	0.079"	0.051"	1.752"	0.146	66.00
CO1052	1-1/8" x 1/2" Reducing Coupling	100	0.079"	0.026"	1.673"	0.132	60.00
CO1056	1-3/8" x 1-1/8" Reducing Coupling	60	0.098"	0.059"	1.831"	0.234	106.00
CO1058	1-3/8" x 7/8" Reducing Coupling	60	0.098"	0.051"	1.949"	0.231	105.00
CO1059	1-3/8" x 3/4" Reducing Coupling	60	0.098"	0.043"	1.831"	0.220	100.00
CO1060	1-3/8" x 5/8" Reducing Coupling	60	0.098"	0.031"	1.752"	0.209	95.00
CO1061	1-3/8" x 1/2" Reducing Coupling	60	0.098"	0.026"	1.831"	0.214	97.00
CO1064	1-5/8" x 1-3/8" Reducing Coupling	30	0.110"	0.079"	1.949"	0.328	149.00
CO1065	1-5/8" x 1-1/8" Reducing Coupling	30	0.110"	0.059"	2.067"	0.320	145.00
CO1067	1-5/8" x 7/8" Reducing Coupling	30	0.110"	0.051"	2.087"	0.304	138.00
CO1068	1-5/8" x 3/4" Reducing Coupling	30	0.110"	0.043"	2.067"	0.298	135.00
CO1073	2-1/8" x 1-5/8" Reducing Coupling	30	0.138"	0.091"	2.559"	0.675	306.00
CO1074	2-1/8" x 1-3/8" Reducing Coupling	30	0.138"	0.079"	2.559"	0.661	300.00

The information contained herein is not intended to replace the full product installation and safety information available or the experience of a trained product installer. You are required to thoroughly read all installation instructions and product safety information before beginning the installation of a product.

All installations must completely comply with all NDL Industries warnings and instructions, national state and local codes and all applicable ANSI standards.

NDL Industries product specifications in U.S. customary units and metric are approximate and are provided for reference only. For precise measurements, please contact Customer

Service. NDL Industries reserves the right to change or modify product design, construction, specifications, or materials without prior notice and without incurring any obligation to make such changes and modifications on NDL products previously or subsequently sold.

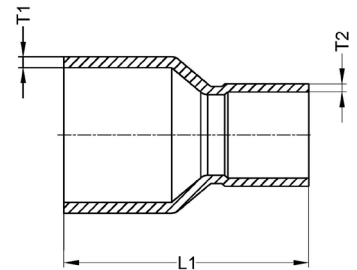

Explore our full line of high-quality HVAC-R, CO₂ Refrigeration, and Hydronic products.

ndlindustries.com | 1-866-635-6888 | sales@ndlinc.com

@ndlindustries





Stake Stop Couplings

Stake Stop Couplings Dimensions and Selection

	PART #	OD - DESCRIPTION	BOX QTY	T1 (IN)	L1 (IN)	WT (LB)	WT (G)
	CO10143	3/8" Coupling with Stake Stop	100	0.028"	0.768"	0.009	4.00
	CO10144	1/2" Coupling with Stake Stop	100	0.035"	0.886"	0.018	8.00
	CO10145	5/8" Coupling with Stake Stop	100	0.041"	1.043"	0.029	13.00
	CO10157	3/4" Coupling with Stake Stop	100	0.053"	1.161"	0.051	23.00
	CO10146	7/8" Coupling with Stake Stop	100	0.059"	1.516"	0.086	39.00
	CO10147	1-1/8" Coupling with Stake Stop	100	0.079"	1.594"	0.152	69.00
	CO10148	1-3/8" Coupling with Stake Stop	60	0.098"	1.752"	0.258	117.00
	CO10149	1-5/8" Coupling with Stake Stop	30	0.110"	1.929"	0.373	169.00
	CO10150	2-1/8" Coupling with Stake Stop	30	0.138"	2.579"	0.818	371.00

The information contained herein is not intended to replace the full product installation and safety information available or the experience of a trained product installer. You are required to thoroughly read all installation instructions and product safety information before beginning the installation of a product.

All installations must completely comply with all NDL Industries warnings and instructions, national state and local codes and all applicable ANSI standards.

NDL Industries product specifications in U.S. customary units and metric are approximate and are provided for reference only. For precise measurements, please contact Customer

Service. NDL Industries reserves the right to change or modify product design, construction, specifications, or materials without prior notice and without incurring any obligation to make such changes and modifications on NDL products previously or subsequently sold.

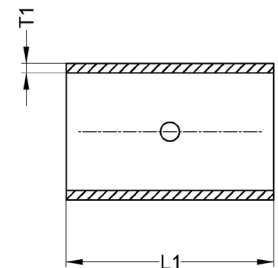

Explore our full line of high-quality
HVAC-R, CO₂ Refrigeration, and Hydronic products.

ndlindustries.com | 1-866-635-6888 | sales@ndlinc.com

@ndlindustries





45° Elbows

45° Elbows Dimensions and Selection

	PART #	OD - DESCRIPTION	BOX QTY	T1 (IN)	L1 (IN)	WT (LB)	WT (G)
	CO3012	3/8" 45° Elbow	100	0.028"	0.709"	0.012	5.50
	CO3021	1/2" 45° Elbow	100	0.035"	0.827"	0.022	10.00
	CO3026	5/8" 45° Elbow	100	0.041"	1.083"	0.042	19.00
	CO3030	3/4" 45° Elbow	100	0.053"	1.181"	0.068	31.00
	CO3034	7/8" 45° Elbow	100	0.059"	1.496"	0.117	53.00
	CO3044	1-1/8" 45° Elbow	100	0.079"	1.614"	0.223	101.00
	CO3050	1-3/8" 45° Elbow	30	0.098"	1.791"	0.379	172.00
	CO3055	1-5/8" 45° Elbow	20	0.110"	1.949"	0.560	254.00
	CO3059	2-1/8" 45° Elbow	10	0.138"	2.402"	1.653	750.00

The information contained herein is not intended to replace the full product installation and safety information available or the experience of a trained product installer. You are required to thoroughly read all installation instructions and product safety information before beginning the installation of a product.

All installations must completely comply with all NDL Industries warnings and instructions, national state and local codes and all applicable ANSI standards.

NDL Industries product specifications in U.S. customary units and metric are approximate and are provided for reference only. For precise measurements, please contact Customer

Service. NDL Industries reserves the right to change or modify product design, construction, specifications, or materials without prior notice and without incurring any obligation to make such changes and modifications on NDL products previously or subsequently sold.

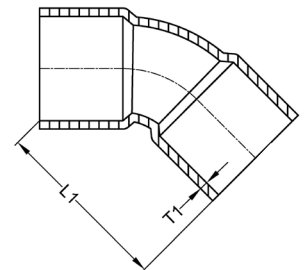



45° Street Elbows

45° Street Elbows Dimensions and Selection

PART #	OD - DESCRIPTION	BOX QTY	T1 (IN)	L1 (IN)	L2 (IN)	WT (LB)	WT (G)
CO3312	3/8" 45° Street Elbow	100	0.028"	0.787"	0.827"	0.011	5.00
CO3321	1/2" 45° Street Elbow	100	0.035"	0.984"	1.024"	0.022	10.00
CO3326	5/8" 45° Street Elbow	100	0.041"	1.220"	1.260"	0.042	19.00
CO3330	3/4" 45° Street Elbow	100	0.053"	1.417"	1.378"	0.077	35.00
CO3334	7/8" 45° Street Elbow	100	0.059"	1.654"	1.614"	0.117	53.00
CO3344	1-1/8" 45° Street Elbow	100	0.079"	1.850"	1.811"	0.227	103.00
CO3350	1-3/8" 45° Street Elbow	30	0.098"	2.047"	2.087"	0.388	176.00
CO3355	1-5/8" 45° Street Elbow	20	0.110"	2.303"	2.264"	0.567	257.00
CO3359	2-1/8" 45° Street Elbow	10	0.138"	2.717"	2.677"	0.992	450.00

The information contained herein is not intended to replace the full product installation and safety information available or the experience of a trained product installer. You are required to thoroughly read all installation instructions and product safety information before beginning the installation of a product.

All installations must completely comply with all NDL Industries warnings and instructions, national state and local codes and all applicable ANSI standards.

NDL Industries product specifications in U.S. customary units and metric are approximate and are provided for reference only. For precise measurements, please contact Customer

Service. NDL Industries reserves the right to change or modify product design, construction, specifications, or materials without prior notice and without incurring any obligation to make such changes and modifications on NDL products previously or subsequently sold.

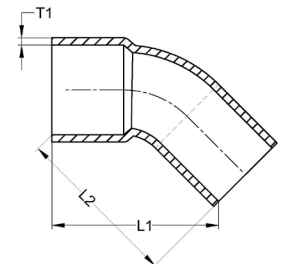

Explore our full line of high-quality HVAC-R, CO₂ Refrigeration, and Hydronic products.

ndlindustries.com | 1-866-635-6888 | sales@ndlinc.com

@ndlindustries





90° Long Radius Elbows

90° Long Radius Elbows Dimensions and Selection

	PART #	OD - DESCRIPTION	BOX QTY	T1 (IN)	L1 (IN)	WT (LB)	WT (G)
	CO2716	3/8" 90° Long Radius Elbow	100	0.028"	1.063"	0.017	7.50
	CO2717	1/2" 90° Long Radius Elbow	100	0.035"	1.398"	0.036	16.50
	CO2722	5/8" 90° Long Radius Elbow	100	0.041"	1.713"	0.066	30.00
	CO2728	3/4" 90° Long Radius Elbow	100	0.053"	2.106"	0.121	55.00
	CO2734	7/8" 90° Long Radius Elbow	100	0.059"	2.224"	0.119	54.00
	CO2747	1-1/8" 90° Long Radius Elbow	100	0.079"	2.717"	0.320	145.00
	CO2055	1-3/8" 90° Long Radius Elbow	30	0.098"	3.268"	0.628	285.00
	CO2063	1-5/8" 90° Long Radius Elbow	30	0.110"	4.232"	1.190	540.00
	CO2072	2-1/8" 90° Long Radius Elbow	10	0.138"	6.693"	3.097	1405.00

The information contained herein is not intended to replace the full product installation and safety information available or the experience of a trained product installer. You are required to thoroughly read all installation instructions and product safety information before beginning the installation of a product.

All installations must completely comply with all NDL Industries warnings and instructions, national state and local codes and all applicable ANSI standards.

NDL Industries product specifications in U.S. customary units and metric are approximate and are provided for reference only. For precise measurements, please contact Customer

Service. NDL Industries reserves the right to change or modify product design, construction, specifications, or materials without prior notice and without incurring any obligation to make such changes and modifications on NDL products previously or subsequently sold.

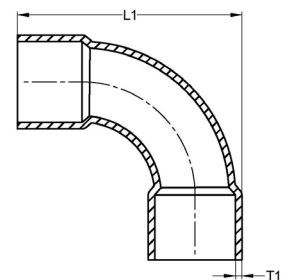



90° Long Radius Street Elbows

90° Long Radius Street Elbows Dimensions and Selection

PART #	OD - DESCRIPTION	BOX QTY	T1 (IN)	L1 (IN)	L2 (IN)	WT (LB)	WT (G)
CO2809	3/8" 90° Long Radius Street Elbow	100	0.028"	1.063"	1.220"	0.018	8.00
CO2817	1/2" 90° Long Radius Street Elbow	100	0.035"	1.398"	1.457"	0.037	17.00
CO2822	5/8" 90° Long Radius Street Elbow	100	0.041"	1.693"	1.772"	0.064	29.00
CO2828	3/4" 90° Long Radius Street Elbow	100	0.053"	2.047"	2.165"	0.123	56.00
CO2834	7/8" 90° Long Radius Street Elbow	100	0.059"	2.126"	2.244"	0.168	76.00
CO2847	1-1/8" 90° Long Radius Street Elbow	100	0.079"	2.717"	2.874"	0.342	155.00
CO2350	1-3/8" 90° Long Radius Street Elbow	30	0.098"	3.228"	3.346"	0.606	275.00
CO2355	1-5/8" 90° Long Radius Street Elbow	20	0.110"	4.213"	4.252"	1.149	521.00
CO2359	2-1/8" 90° Long Radius Street Elbow	10	0.138"	6.516"	6.949"	3.086	1400.00

The information contained herein is not intended to replace the full product installation and safety information available or the experience of a trained product installer. You are required to thoroughly read all installation instructions and product safety information before beginning the installation of a product.

All installations must completely comply with all NDL Industries warnings and instructions, national state and local codes and all applicable ANSI standards.

NDL Industries product specifications in U.S. customary units and metric are approximate and are provided for reference only. For precise measurements, please contact Customer

Service. NDL Industries reserves the right to change or modify product design, construction, specifications, or materials without prior notice and without incurring any obligation to make such changes and modifications on NDL products previously or subsequently sold.

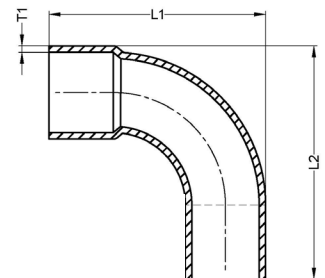

Explore our full line of high-quality
HVAC-R, CO₂ Refrigeration, and Hydronic products.

ndlindustries.com | 1-866-635-6888 | sales@ndlinc.com

@ndlindustries





Tees Dimensions and Selection

PART #	OD - DESCRIPTION	BOX QTY	T1 (IN)	L1 (IN)	L2 (IN)	WT (LB)	WT (G)
CO4000	3/8" Tee	100	0.028"	1.043"	0.807"	0.022	10.00
CO4001	1/2" Tee	100	0.035"	1.437"	1.043"	0.049	22.00
CO4006	5/8" Tee	100	0.041"	1.634"	1.161"	0.073	33.00
CO4017	3/4" Tee	100	0.053"	1.949"	1.398"	0.134	61.00
CO4031	7/8" Tee	100	0.059"	2.264"	1.713"	0.201	91.00
CO4048	1-1/8" Tee	100	0.079"	2.894"	2.146"	0.441	200.00
CO4068	1-3/8" Tee	30	0.098"	3.366"	2.461"	0.734	333.00
CO4084	1-5/8" Tee	20	0.110"	3.642"	2.953"	1.054	478.00
CO40102	2-1/8" Tee	15	0.138"	4.980"	3.681"	2.371	1075.50

The information contained herein is not intended to replace the full product installation and safety information available or the experience of a trained product installer. You are required to thoroughly read all installation instructions and product safety information before beginning the installation of a product.

All installations must completely comply with all NDL Industries warnings and instructions, national state and local codes and all applicable ANSI standards.

NDL Industries product specifications in U.S. customary units and metric are approximate and are provided for reference only. For precise measurements, please contact Customer

Service. NDL Industries reserves the right to change or modify product design, construction, specifications, or materials without prior notice and without incurring any obligation to make such changes and modifications on NDL products previously or subsequently sold.

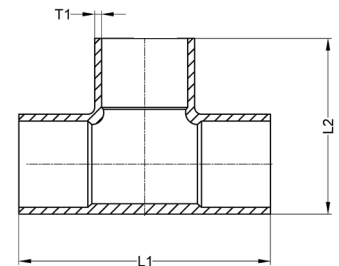

Explore our full line of high-quality HVAC-R, CO₂ Refrigeration, and Hydronic products.

ndlindustries.com | 1-866-635-6888 | sales@ndlinc.com

@ndlindustries





Reducing Tees

Reducing Tees Dimensions and Selection

PART #	OD - DESCRIPTION	BOX QTY	T1 (IN)	T2 (IN)	L1 (IN)	L2 (IN)	WT (LB)	WT (G)
CO4002	1/2" x 1/2" x 3/8" Reducing Tee	EA	0.035"	0.022"	1.280"	1.004"	0.041	18.6
CO4007	5/8" x 5/8" x 1/2" Reducing Tee	EA	0.041"	0.026"	1.437"	1.142"	0.073	33.1
CO4008	5/8" x 5/8" x 3/8" Reducing Tee	EA	0.041"	0.022"	1.437"	1.063"	0.071	32.2
CO4018	3/4" x 3/4" x 5/8" Reducing Tee	EA	0.053"	0.031"	1.988"	1.437"	0.108	49.0
CO4019	3/4" x 3/4" x 1/2" Reducing Tee	EA	0.053"	0.026"	1.673"	1.319"	0.128	58.1
CO4032	7/8" x 7/8" x 3/4" Reducing Tee	EA	0.059"	0.043"	2.441"	1.634"	0.165	74.8
CO4033	7/8" x 7/8" x 5/8" Reducing Tee	EA	0.059"	0.031"	2.224"	1.594"	0.165	74.8
CO4034	7/8" x 7/8" x 1/2" Reducing Tee	EA	0.059"	0.026"	2.067"	1.417"	0.165	74.8
CO4049	1-1/8" x 1-1/8" x 7/8" Reducing Tee	EA	0.079"	0.051"	2.579"	2.106"	0.300	136.1
CO4050	1-1/8" x 1-1/8" x 3/4" Reducing Tee	EA	0.079"	0.043"	2.421"	1.909"	0.273	123.8
CO4069	1-3/8" x 1-3/8" x 1-1/8" Reducing Tee	EA	0.098"	0.059"	2.933"	2.402"	0.520	235.9
CO4070	1-3/8" x 1-3/8" x 7/8" Reducing Tee	EA	0.098"	0.051"	2.776"	2.343"	0.461	209.1
CO4071	1-3/8" x 1-3/8" x 3/4" Reducing Tee	EA	0.098"	0.043"	2.598"	2.165"	0.428	194.1
CO4085	1-5/8" x 1-5/8" x 1-3/8" Reducing Tee	EA	0.110"	0.079"	3.543"	2.677"	0.873	396.0
CO4086	1-5/8" x 1-5/8" x 1-1/8" Reducing Tee	EA	0.110"	0.059"	3.209"	2.677"	1.014	459.9
CO4087	1-5/8" x 1-5/8" x 7/8" Reducing Tee	EA	0.110"	0.051"	3.012"	2.618"	1.058	479.9
CO40103	2-1/8" x 2-1/8" x 1-5/8" Reducing Tee	EA	0.138"	0.091"	4.291"	3.465"	2.205	1000.2

The information contained herein is not intended to replace the full product installation and safety information available or the experience of a trained product installer. You are required to thoroughly read all installation instructions and product safety information before beginning the installation of a product.

All installations must completely comply with all NDL Industries warnings and instructions, national state and local codes and all applicable ANSI standards.

NDL Industries product specifications in U.S. customary units and metric are approximate and are provided for reference only. For precise measurements, please contact Customer

Service. NDL Industries reserves the right to change or modify product design, construction, specifications, or materials without prior notice and without incurring any obligation to make such changes and modifications on NDL products previously or subsequently sold.

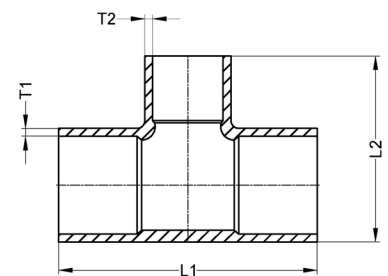

Explore our full line of high-quality
HVAC-R, CO₂ Refrigeration, and Hydronic products.

ndlindustries.com | 1-866-635-6888 | sales@ndlinc.com

@ndlindustries





Reducing Tees

Reducing Tees Dimensions and Selection

	PART #	OD - DESCRIPTION	BOX QTY	T1 (IN)	T2 (IN)	T3 (IN)	L1 (IN)	L2 (IN)	WT (LB)	WT (G)
	CO4004	1/2" x 3/8" x 3/8" Reducing Tee	EA	0.035"	0.022"	0.022"	1.437"	0.965"	0.042	19.00
	CO4010	5/8" x 1/2" x 1/2" Reducing Tee	EA	0.041"	0.026"	0.026"	1.634"	1.122"	0.066	30.00
	CO4059	1-1/8" x 7/8" x 1/2" Reducing Tee	EA	0.079"	0.051"	0.026"	2.677"	1.752"	0.355	161.00

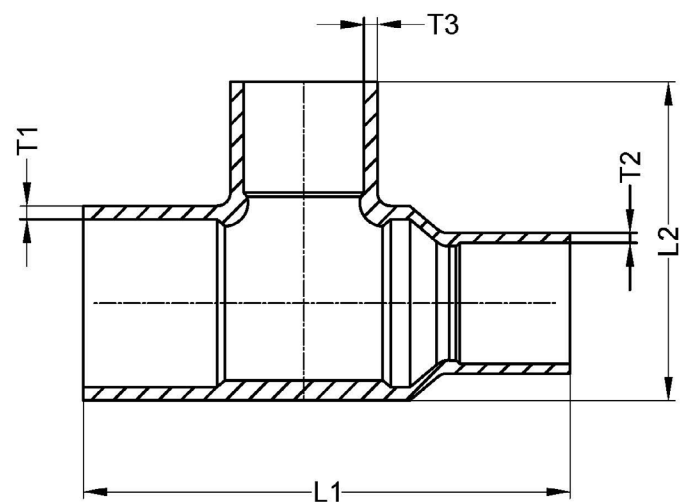

The information contained herein is not intended to replace the full product installation and safety information available or the experience of a trained product installer. You are required to thoroughly read all installation instructions and product safety information before beginning the installation of a product.

All installations must completely comply with all NDL Industries warnings and instructions, national state and local codes and all applicable ANSI standards.

NDL Industries product specifications in U.S. customary units and metric are approximate and are provided for reference only. For precise measurements, please contact Customer.

Service. NDL Industries reserves the right to change or modify product design, construction, specifications, or materials without prior notice and without incurring any obligation to make such changes and modifications on NDL products previously or subsequently sold.



Explore our full line of high-quality HVAC-R, CO₂ Refrigeration, and Hydronic products.

ndlindustries.com | 1-866-635-6888 | sales@ndlinc.com

@ndlindustries





Service Tees

Service Tees Dimensions and Selection

	PART #	OD - DESCRIPTION	BOX QTY	T1 (IN)	T2 (IN)	L1 (IN)	L2 (IN)	WT (LB)	WT (G)
	CO4001S	1/2" x 1/2" x 10 mm Reducing Tee	EA	0.035	0.033	1.280"	1.043"	0.055	25.00
	CO4006S	5/8" x 5/8" x 10 mm Reducing Tee	EA	0.041	0.033	1.437"	1.122"	0.066	32.00
	CO4017S	3/4" x 3/4" x 10 mm Reducing Tee	EA	0.053	0.033	1.634"	1.319"	0.110	50.00
	CO4031S	7/8" x 7/8" x 10 mm Reducing Tee	EA	0.059	0.033	2.067"	1.457"	0.183	83.00
	CO4048S	1-1/8" x 1-1/8" x 10 mm Reducing Tee	EA	0.079	0.033	2.106"	1.791"	0.30	136.00
	CO4068S	1-3/8" 1-3/8" x 10 mm Reducing Tee	EA	0.098	0.033	2.323"	2.008"	0.551	250.00
	CO4084S	1-5/8" x 1-5/8" x 10 mm Reducing Tee	EA	0.110	0.033	2.539"	2.283"	0.772	350.00
	CO40102S	2-1/8" x 2-1/8" x 10 mm Reducing Tee	EA	0.138	0.033	3.425"	2.894"	1.764	800.00

The information contained herein is not intended to replace the full product installation and safety information available or the experience of a trained product installer. You are required to thoroughly read all installation instructions and product safety information before beginning the installation of a product.

All installations must completely comply with all NDL Industries warnings and instructions, national state and local codes and all applicable ANSI standards.

NDL Industries product specifications in U.S. customary units and metric are approximate and are provided for reference only. For precise measurements, please contact Customer

Service. NDL Industries reserves the right to change or modify product design, construction, specifications, or materials without prior notice and without incurring any obligation to make such changes and modifications on NDL products previously or subsequently sold.

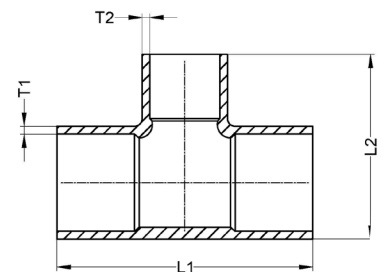

Explore our full line of high-quality
HVAC-R, CO₂ Refrigeration, and Hydronic products.

ndlindustries.com | 1-866-635-6888 | sales@ndlinc.com

@ndlindustries

