



ACR Copper Fittings

TECHNICAL SPECIFICATIONS SUBMITTAL FORM

Job Name:	Submittal Date:	Wholesaler:
Job Location:	Engineer/Architect:	Contractor:

Product Use:

ACR Copper Fittings for use in HVAC and Refrigeration Applications.

Design and Features:

- NDL ensures copper quality content and strict adherence to meet or exceed ASME B16.22 standards for wall thickness.
- Our ACR copper fittings are tested for actual burst pressure and approved by TSSA.
- Each fitting is marked with OD size for easy field identification.
- Fittings are poly-bagged within the box, keeping them clean and contaminant-free prior to installation.
- The fittings have tight tolerances on the cup side for a stronger joint with the tube and easier brazing.
- The unparalleled NDL 10 Year Ultimate Protection Warranty will cover the loss of refrigerant and labor to replace the failed fitting.
- Our copper fittings have zero reported failures since 1999.

Design and Features:

- TSSA
- CRN Approved
- ANSI/ASME B16.22
- UL Certified (SA45869) for sizes up to and including 2-5/8"

Design Pressure Table (Based on UL Certification - SA45869)

SIZE (IN)	PSI (AT 250 °F)	BAR (AT 121 °C)
1/4"	1000	68.9
3/8"	1000	68.9
1/2"	1000	68.9
5/8"	1000	68.9
3/4"	1000	68.9
7/8"	900	62
1-1/8"	700	48.2
1-3/8"	700	48.2
1-5/8"	700	48.2
2-1/8"	700	48.2
2-5/8"	700	48.2

Above 2-5/8" according to ASME B16.22





Female Adapters

Female Adapter Dimensions and Selection

PART #	OD - DESCRIPTION	BOX QTY	L1 (IN)	WT (LB)	WT (G)
W1215	3/8" x 1/4" Female Adapter	50	0.906"	0.033	15.0
W1231	5/8" x 1/2" Female Adapter	50	1.222"	0.079	36.0
W1232	5/8" x 3/8" Female Adapter	50	0.945"	0.079	36.0
W1224	1/2" x 1/2" Female Adapter	50	1.181"	0.090	41.0
W1230	5/8" x 3/4" Female Adapter	25	1.299"	0.110	50.0
W1246	7/8" x 3/4" Female Adapter	25	1.437"	0.141	64.0
W1238	3/4" x 3/4" Female Adapter	25	1.457"	0.141	64.0
W1263	1-1/8" x 1" Female Adapter	25	1.732"	0.229	104.0
W1271	1-3/8" x 1-1/4" Female Adapter	10	1.909"	0.331	150.0
W1279	1-5/8" x 1-1/2" Female Adapter	10	2.126"	0.459	208.0
W1287	2-1/8" x 2" Female Adapter	5	2.421"	0.705	320.0

The information contained herein is not intended to replace the full product installation and safety information available or the experience of a trained product installer. You are required to thoroughly read all installation instructions and product safety information before beginning the installation of a product.

All installations must completely comply with all NDL Industries warnings and instructions, national state and local codes and all applicable ANSI standards.

NDL Industries product specifications in U.S. customary units and metric are approximate and are provided for reference only. For precise measurements, please contact Customer

Service. NDL Industries reserves the right to change or modify product design, construction, specifications, or materials without prior notice and without incurring any obligation to make such changes and modifications on NDL products previously or subsequently sold.

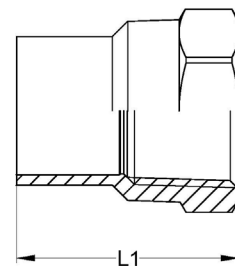

Explore our full line of high-quality HVAC-R, CO₂ Refrigeration, and Hydronic products.

ndlindustries.com | 1-866-635-6888 | sales@ndlinc.com

@ndlindustries





Male Adapters

Male Adapter Dimensions and Selection

	PART #	OD - DESCRIPTION	BOX QTY	L1 (IN)	WT (LB)	WT (G)
	W1132	5/8" x 3/8" Male Adapter	50	0.965"	0.079	36
	W1146	7/8" x 3/4" Male Adapter	50	1.378"	0.128	58
	W1130	5/8" x 3/4" Male Adapter	25	1.378"	0.13	59
	W1138	3/4" x 3/4" Male Adapter	25	1.584"	0.141	64
	W1145	7/8" x 1" Male Adapter	10	2.106"	0.22	100
	W1163	1-1/8" x 1" Male Adapter	25	1.673"	0.229	104
	W1172	1-3/8" x 1" Male Adapter	10	1.969"	0.28	127
	W1171	1-3/8" x 1-1/4" Male Adapter	20	1.693"	0.331	150
	W1180	1-5/8" x 1-1/4" Male Adapter	10	1.929"	0.45	204
	W1179	1-5/8" x 1-1/2" Male Adapter	10	1.909"	0.461	209
	W1187	2-1/8" x 2" Male Adapter	5	2.264"	0.71	322

The information contained herein is not intended to replace the full product installation and safety information available or the experience of a trained product installer. You are required to thoroughly read all installation instructions and product safety information before beginning the installation of a product.

All installations must completely comply with all NDL Industries warnings and instructions, national state and local codes and all applicable ANSI standards.

NDL Industries product specifications in U.S. customary units and metric are approximate and are provided for reference only. For precise measurements, please contact Customer

Service. NDL Industries reserves the right to change or modify product design, construction, specifications, or materials without prior notice and without incurring any obligation to make such changes and modifications on NDL products previously or subsequently sold.

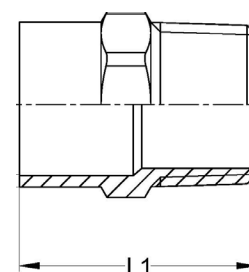

Explore our full line of high-quality HVAC-R, CO₂ Refrigeration, and Hydronic products.

ndlindustries.com | 1-866-635-6888 | sales@ndlinc.com

@ndlindustries





Reducing Bushings

Reducing Bushing Dimensions and Selection

PART #	OD - DESCRIPTION	BOX QTY	L1 (IN)	WT (LB)	WT (G)
W1306	3/8" x 1/4" Reducing Bushing	50	0.827"	0.009	4.1
W1312	1/2" x 3/8" Reducing Bushing	50	0.945"	0.015	6.8
W1314	1/2" x 1/4" Reducing Bushing	50	0.994"	0.014	6.5
W1315	5/8" x 1/2" Reducing Bushing	50	1.240"	0.027	12.1
W1317	5/8" x 3/8" Reducing Bushing	50	1.193"	0.027	12.4
W1320	3/4" x 5/8" Reducing Bushing	50	1.406"	0.041	18.5
W1321	3/4" x 1/2" Reducing Bushing	50	1.437"	0.038	17.3
W1325	7/8" x 3/4" Reducing Bushing	50	1.693"	0.067	30.3
W1326	7/8" x 5/8" Reducing Bushing	50	1.610"	0.066	30.0
W1327	7/8" x 1/2" Reducing Bushing	50	1.575"	0.065	29.5
W1328	7/8" x 3/8" Reducing Bushing	50	1.555"	0.065	29.4
W1337	1-1/8" x 7/8" Reducing Bushing	25	2.063"	0.115	52.0
W1338	1-1/8" x 3/4" Reducing Bushing	25	1.886"	0.104	47.0
W1339	1-1/8" x 5/8" Reducing Bushing	25	1.858"	0.106	48.0
W1340	1-1/8" x 1/2" Reducing Bushing	25	1.850"	0.108	49.0
W1343	1-3/8" x 1-1/8" Reducing Bushing	10	2.240"	0.174	78.9
W1345	1-3/8" x 7/8" Reducing Bushing	10	2.195"	0.146	66.2
W1347	1-3/8" x 5/8" Reducing Bushing	10	2.063"	0.15	68.0
W1350	1-5/8" x 1-3/8" Reducing Bushing	10	2.496"	0.236	107.0
W1351	1-5/8" x 1-1/8" Reducing Bushing	10	2.638"	0.24	108.9
W1353	1-5/8" x 7/8" Reducing Bushing	10	2.457"	0.231	104.8
W1355	1-5/8" x 5/8" Reducing Bushing	10	2.339"	0.231	104.8
W1358	2-1/8" x 1-5/8" Reducing Bushing	15	3.031"	0.419	190.1
W1359	2-1/8" x 1-3/8" Reducing Bushing	15	2.992"	0.37	167.8
W1360	2-1/8" x 1-1/8" Reducing Bushing	15	3.071"	0.37	167.8
W1362	2-1/8" x 7/8" Reducing Bushing	15	2.953"	0.386	175.1

The information contained herein is not intended to replace the full product installation and safety information available or the experience of a trained product installer. You are required to thoroughly read all installation instructions and product safety information before beginning the installation of a product.

All installations must completely comply with all NDL Industries warnings and instructions, national state and local codes and all applicable ANSI standards.

NDL Industries product specifications in U.S. customary units and metric are approximate and are provided for reference only. For precise measurements, please contact Customer

Service. NDL Industries reserves the right to change or modify product design, construction, specifications, or materials without prior notice and without incurring any obligation to make such changes and modifications on NDL products previously or subsequently sold.

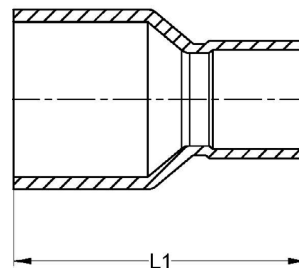

Explore our full line of high-quality
HVAC-R, CO₂ Refrigeration, and Hydronic products.

ndlindustries.com | 1-866-635-6888 | sales@ndlinc.com

@ndlindustries





Reducing Bushings - Continued

Reducing Bushing Dimensions and Selection

PART #	OD - DESCRIPTION	BOX QTY	L1 (IN)	WT (LB)	WT (G)
W1364	2-1/8" x 5/8" Reducing Bushing	15	2.894"	0.386	175.1
W1367	2-5/8" x 2-1/8" Reducing Bushing	12	3.465"	0.644	292.1
W1368	2-5/8" x 1-5/8" Reducing Bushing	15	3.366"	0.6	272.2
W1369	2-5/8" x 1-3/8" Reducing Bushing	15	3.287"	0.617	279.9
W1370	2-5/8" x 1-1/8" Reducing Bushing	10	3.465"	0.551	249.9
W1376	3-1/8" x 2-5/8" Reducing Bushing	6	3.815"	0.904	410.0
W1377	3-1/8" x 2-1/8" Reducing Bushing	6	3.878"	0.904	410.0
W1379	3-1/8" x 1-3/8" Reducing Bushing	6	3.858"	0.882	400.1
W1381	3-5/8" x 3-1/8" Reducing Bushing	4	4.134"	1.378	625.0
W1383	3-5/8" x 2-1/8" Reducing Bushing	4	4.429"	1.499	679.9
W1387	4-1/8" x 3-1/8" Reducing Bushing	2	4.756"	1.984	899.9
W1388	4-1/8" x 2-5/8" Reducing Bushing	2	4.803"	2.028	919.9

The information contained herein is not intended to replace the full product installation and safety information available or the experience of a trained product installer. You are required to thoroughly read all installation instructions and product safety information before beginning the installation of a product.

All installations must completely comply with all NDL Industries warnings and instructions, national state and local codes and all applicable ANSI standards.

NDL Industries product specifications in U.S. customary units and metric are approximate and are provided for reference only. For precise measurements, please contact Customer

Service. NDL Industries reserves the right to change or modify product design, construction, specifications, or materials without prior notice and without incurring any obligation to make such changes and modifications on NDL products previously or subsequently sold.

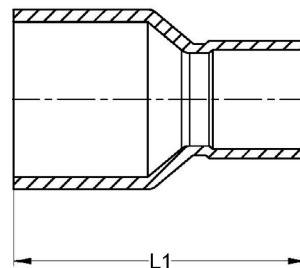

Explore our full line of high-quality HVAC-R, CO₂ Refrigeration, and Hydronic products.

ndlindustries.com | 1-866-635-6888 | sales@ndlinc.com

@ndlindustries





Cap Dimensions and Selection

PART #	OD - DESCRIPTION	BOX QTY	L1 (IN)	WT (LB)	WT (G)
W7002	1/4" Cap	50	0.299"	0.003	1.5
W7004	3/8" Cap	100	0.394"	0.005	2.3
W7006	1/2" Cap	50	0.433"	0.009	4.0
W7007	5/8" Cap	100	0.571"	0.015	7.0
W7008	3/4" Cap	50	0.720"	0.026	12.0
W7009	7/8" Cap	50	0.870"	0.033	15.0
W7011	1-1/8" Cap	50	0.984"	0.066	30.0
W7012	1-3/8" Cap	25	1.114"	0.104	47.0
W7013	1-5/8" Cap	25	1.244"	0.148	67.0
W7014	2-1/8" Cap	10	1.528"	0.265	120.0
W7015	2-5/8" Cap	10	1.673"	0.441	200.0
W7016	3-1/8" Cap	2	1.890"	0.540	245.0
W7018	4-1/8" Cap	EA	2.165"	1.257	570.0

The information contained herein is not intended to replace the full product installation and safety information available or the experience of a trained product installer. You are required to thoroughly read all installation instructions and product safety information before beginning the installation of a product.

All installations must completely comply with all NDL Industries warnings and instructions, national state and local codes and all applicable ANSI standards.

NDL Industries product specifications in U.S. customary units and metric are approximate and are provided for reference only. For precise measurements, please contact Customer

Service. NDL Industries reserves the right to change or modify product design, construction, specifications, or materials without prior notice and without incurring any obligation to make such changes and modifications on NDL products previously or subsequently sold.

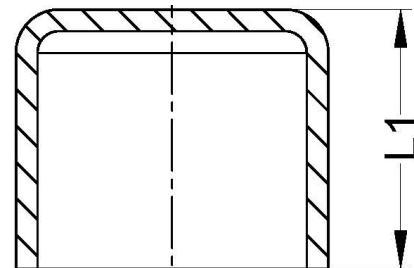

Explore our full line of high-quality HVAC-R, CO₂ Refrigeration, and Hydronic products.

ndlindustries.com | 1-866-635-6888 | sales@ndlinc.com

@ndlindustries





No Stop Couplings

No Stop Coupling Dimensions and Selection

	PART #	OD - DESCRIPTION	BOX QTY	L1 (IN)	WT (LB)	WT (G)
	W1900	1/4" No Stop Coupling	100	0.555"	0.006	2.5
	W1901	3/8" No Stop Coupling	50	0.709"	0.009	4.0
	W1902	1/2" No Stop Coupling	50	0.807"	0.015	6.9
	W1903	5/8" No Stop Coupling	100	1.051"	0.024	11.0
	W1904	3/4" No Stop Coupling	25	1.276"	0.044	20.0
	W1905	7/8" No Stop Coupling	50	1.642"	0.088	40.0
	W1906	1-1/8" No Stop Coupling	25	1.874"	0.106	48.0
	W1907	1-3/8" No Stop Coupling	25	1.953"	0.165	74.8

The information contained herein is not intended to replace the full product installation and safety information available or the experience of a trained product installer. You are required to thoroughly read all installation instructions and product safety information before beginning the installation of a product.

All installations must completely comply with all NDL Industries warnings and instructions, national state and local codes and all applicable ANSI standards.

NDL Industries product specifications in U.S. customary units and metric are approximate and are provided for reference only. For precise measurements, please contact Customer

Service. NDL Industries reserves the right to change or modify product design, construction, specifications, or materials without prior notice and without incurring any obligation to make such changes and modifications on NDL products previously or subsequently sold.

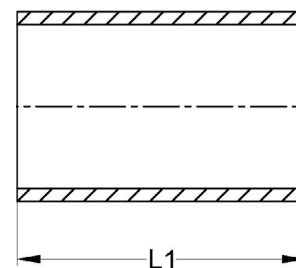

Explore our full line of high-quality HVAC-R, CO₂ Refrigeration, and Hydronic products.

ndlindustries.com | 1-866-635-6888 | sales@ndlinc.com

@ndlindustries





Reducing Couplings

Reducing Coupling Dimensions and Selection

PART #	OD - DESCRIPTION	BOX QTY	L1 (IN)	WT (LB)	WT (G)
W1011	3/8" x 1/4" Reducing Coupling	50	0.791"	0.01	4.6
W1010	3/8" x 5/16" Reducing Coupling	50	0.807"	0.011	5
W1021	1/2" x 1/4" Reducing Coupling	50	0.974"	0.016	7.1
W1019	1/2" x 3/8" Reducing Coupling	50	0.953"	0.017	7.6
W1023	5/8" x 1/2" Reducing Coupling	100	1.169"	0.033	15.1
W1025	5/8" x 3/8" Reducing Coupling	100	1.142"	0.033	15
W1027	5/8" x 1/4" Reducing Coupling	100	1.24"	0.035	15.8
W1031	3/4" x 3/8" Reducing Coupling	100	1.402"	0.04	18
W1029	3/4" x 5/8" Reducing Coupling	100	1.457"	0.045	20.6
W1030	3/4" x 1/2" Reducing Coupling	100	1.319"	0.046	21
W1038	7/8" x 3/8" Reducing Coupling	50	1.48"	0.056	25.4
W1037	7/8" x 1/2" Reducing Coupling	50	1.575"	0.061	27.8
W1035	7/8" x 3/4" Reducing Coupling	50	1.626"	0.072	32.5
W1036	7/8" x 5/8" Reducing Coupling	50	1.594"	0.075	34
W1052	1-1/8" x 1/2" Reducing Coupling	25	1.839"	0.099	45
W1050	1-1/8" x 3/4" Reducing Coupling	25	1.941"	0.115	52
W1051	1-1/8" x 5/8" Reducing Coupling	25	1.906"	0.115	52
W1049	1-1/8" x 7/8" Reducing Coupling	25	2.059"	0.121	55
W1060	1-3/8" x 5/8" Reducing Coupling	10	2.126"	0.165	75
W1058	1-3/8" x 7/8" Reducing Coupling	10	2.22"	0.172	78
W1056	1-3/8" x 1-1/8" Reducing Coupling	10	2.307"	0.187	85
W1069	1-5/8" x 5/8" Reducing Coupling	10	2.362"	0.209	95
W1065	1-5/8" x 1-1/8" Reducing Coupling	10	2.539"	0.247	112
W1067	1-5/8" x 7/8" Reducing Coupling	10	2.492"	0.255	115.5
W1064	1-5/8" x 1-3/8" Reducing Coupling	10	2.608"	0.287	130
W1075	2-1/8" x 1-1/8" Reducing Coupling	15	3.012"	0.366	166

The information contained herein is not intended to replace the full product installation and safety information available or the experience of a trained product installer. You are required to thoroughly read all installation instructions and product safety information before beginning the installation of a product.

All installations must completely comply with all NDL Industries warnings and instructions, national state and local codes and all applicable ANSI standards.

NDL Industries product specifications in U.S. customary units and metric are approximate and are provided for reference only. For precise measurements, please contact Customer.

Service. NDL Industries reserves the right to change or modify product design, construction, specifications, or materials without prior notice and without incurring any obligation to make such changes and modifications on NDL products previously or subsequently sold.

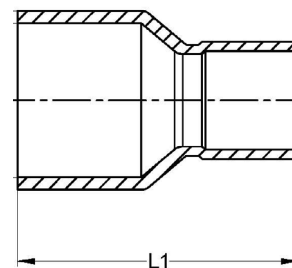

Explore our full line of high-quality
HVAC-R, CO₂ Refrigeration, and Hydronic products.

ndlindustries.com | 1-866-635-6888 | sales@ndlinc.com

@ndlindustries





Reducing Couplings - Continued

Reducing Coupling Dimensions and Selection

PART #	OD - DESCRIPTION	BOX QTY	L (IN)	WT (LB)	WT (G)
W1074	2-1/8" x 1-3/8" Reducing Coupling	15	2.972"	0.384	174
W1073	2-1/8" x 1-5/8" Reducing Coupling	15	3.031"	0.397	180
W1079	2-1/8" x 5/8" Reducing Coupling	15	2.854"	0.397	180
W1086	2-5/8" x 1-1/8" Reducing Coupling	12	3.543"	0.606	275
W1085	2-5/8" x 1-3/8" Reducing Coupling	12	3.346"	0.661	300
W1083	2-5/8" x 2-1/8" Reducing Coupling	12	3.472"	0.679	308
W1084	2-5/8" x 1-5/8" Reducing Coupling	12	3.484"	0.679	308
W1095	3-1/8" x 1-5/8" Reducing Coupling	6	3.878"	0.882	400
W1094	3-1/8" x 2-1/8" Reducing Coupling	6	3.858"	0.957	434
W1093	3-1/8" x 2-5/8" Reducing Coupling	6	4.008"	1.019	462
W10109	4-1/8" x 3-1/8" Reducing Coupling	EA	4.921"	2.094	950
W10110	4-1/8" x 2-5/8" Reducing Coupling	EA	4.941"	2.094	950

The information contained herein is not intended to replace the full product installation and safety information available or the experience of a trained product installer. You are required to thoroughly read all installation instructions and product safety information before beginning the installation of a product.

All installations must completely comply with all NDL Industries warnings and instructions, national state and local codes and all applicable ANSI standards.

NDL Industries product specifications in U.S. customary units and metric are approximate and are provided for reference only. For precise measurements, please contact Customer

Service. NDL Industries reserves the right to change or modify product design, construction, specifications, or materials without prior notice and without incurring any obligation to make such changes and modifications on NDL products previously or subsequently sold.

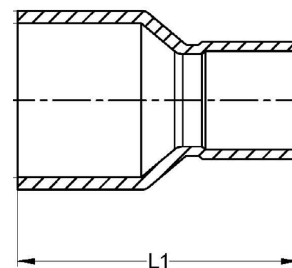

Explore our full line of high-quality HVAC-R, CO₂ Refrigeration, and Hydronic products.

ndlindustries.com | 1-866-635-6888 | sales@ndlinc.com

@ndlindustries





Roll Stop Couplings

Roll Stop Coupling Dimensions and Selection

	PART #	OD - DESCRIPTION	BOX QTY	L1 (IN)	WT (LB)	WT (G)
	W1003	1/4" Roll Stop Coupling	100	0.630"	0.006	2.7
	W1009	3/8" Roll Stop Coupling	50	0.720"	0.009	4.2
	W1017	1/2" Roll Stop Coupling	50	0.886"	0.016	7.1
	W1022	5/8" Roll Stop Coupling	100	1.110"	0.030	13.5
	W1028	3/4" Roll Stop Coupling	50	1.354"	0.043	19.5
	W1034	7/8" Roll Stop Coupling	50	1.642"	0.091	41.5
	W1047	1-1/8" Roll Stop Coupling	25	1.957"	0.151	68.5
	W1055	1-3/8" Roll Stop Coupling	25	2.055"	0.165	75.0
	W1063	1-5/8" Roll Stop Coupling	10	2.323"	0.245	111.0
	W1072	2-1/8" Roll Stop Coupling	6	2.854"	0.425	193.0
	W1082	2-5/8" Roll Stop Coupling	4	3.256"	0.723	328.0
	W1092	3-1/8" Roll Stop Coupling	4	3.689"	1.030	467.0
	W10100	3-5/8" Roll Stop Coupling	EA	4.193"	1.373	623.0
	W10107	4-1/8" Roll Stop Coupling	EA	4.693"	2.094	950.0

The information contained herein is not intended to replace the full product installation and safety information available or the experience of a trained product installer. You are required to thoroughly read all installation instructions and product safety information before beginning the installation of a product.

All installations must completely comply with all NDL Industries warnings and instructions, national state and local codes and all applicable ANSI standards.

NDL Industries product specifications in U.S. customary units and metric are approximate and are provided for reference only. For precise measurements, please contact Customer

Service. NDL Industries reserves the right to change or modify product design, construction, specifications, or materials without prior notice and without incurring any obligation to make such changes and modifications on NDL products previously or subsequently sold.

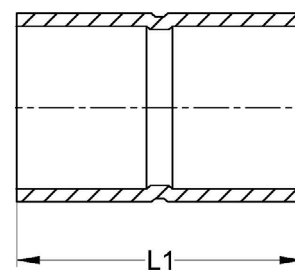

Explore our full line of high-quality HVAC-R, CO₂ Refrigeration, and Hydronic products.

ndlindustries.com | 1-866-635-6888 | sales@ndlinc.com

@ndlindustries



NDL Stake Stop Couplings

Stake Stop Coupling Dimensions and Selection

	PART #	OD - DESCRIPTION	BOX QTY	L1 (IN)	WT (LB)	WT (G)
	W10142	5/16" Stake Stop Coupling	100	0.740"	0.008	3.8

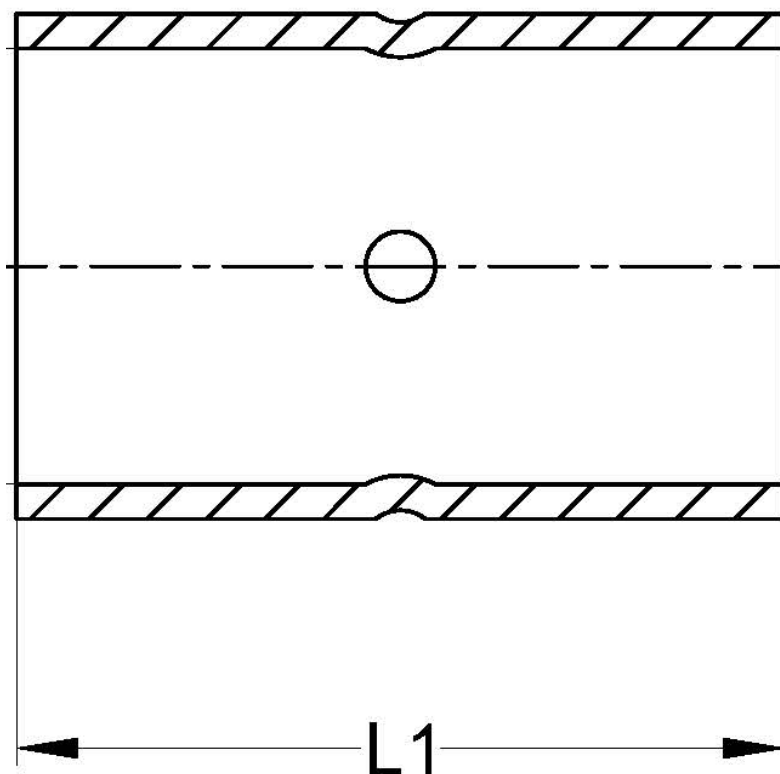

The information contained herein is not intended to replace the full product installation and safety information available or the experience of a trained product installer. You are required to thoroughly read all installation instructions and product safety information before beginning the installation of a product.

All installations must completely comply with all NDL Industries warnings and instructions, national state and local codes and all applicable ANSI standards.

NDL Industries product specifications in U.S. customary units and metric are approximate and are provided for reference only. For precise measurements, please contact Customer

Service. NDL Industries reserves the right to change or modify product design, construction, specifications, or materials without prior notice and without incurring any obligation to make such changes and modifications on NDL products previously or subsequently sold.



Explore our full line of high-quality HVAC-R, CO₂ Refrigeration, and Hydronic products.

ndlindustries.com | 1-866-635-6888 | sales@ndlinc.com

@ndlindustries





45° Elbows

45° Elbow Dimensions and Selection

PART #	OD - DESCRIPTION	BOX QTY	L1 (IN)	WT (LB)	WT (G)
W3005	1/4" 45° Elbow	100	0.665"	0.008	3.8
W3012	3/8" 45° Elbow	50	0.752"	0.013	6.0
W3021	1/2" 45° Elbow	50	0.866"	0.033	15.0
W3026	5/8" 45° Elbow	50	1.102"	0.038	17.3
W3030	3/4" 45° Elbow	50	1.319"	0.068	31.0
W3034	7/8" 45° Elbow	25	1.587"	0.104	47.0
W3044	1-1/8" 45° Elbow	25	2.008"	0.190	86.0
W3050	1-3/8" 45° Elbow	10	2.087"	0.278	126.0
W3055	1-5/8" 45° Elbow	10	2.382"	0.375	170.0
W3059	2-1/8" 45° Elbow	10	2.756"	0.602	273.0
W3063	2-5/8" 45° Elbow	4	3.260"	1.102	500.0
W3067	3-1/8" 45° Elbow	2	3.484"	1.612	731.0

The information contained herein is not intended to replace the full product installation and safety information available or the experience of a trained product installer. You are required to thoroughly read all installation instructions and product safety information before beginning the installation of a product.

All installations must completely comply with all NDL Industries warnings and instructions, national state and local codes and all applicable ANSI standards.

NDL Industries product specifications in U.S. customary units and metric are approximate and are provided for reference only. For precise measurements, please contact Customer

Service. NDL Industries reserves the right to change or modify product design, construction, specifications, or materials without prior notice and without incurring any obligation to make such changes and modifications on NDL products previously or subsequently sold.

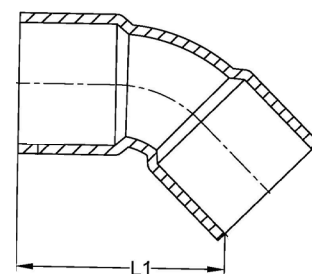

Explore our full line of high-quality HVAC-R, CO₂ Refrigeration, and Hydronic products.

ndlindustries.com | 1-866-635-6888 | sales@ndlinc.com

@ndlindustries





45° Street Elbows

45° Street Elbow Dimensions and Selection

PART #	OD - DESCRIPTION	BOX QTY	L1 (IN)	L2 (IN)	WT (LB)	WT (G)
W3305	1/4" 45° Street Elbow	EA	0.732"	0.720"	0.008	3.8
W3312	3/8" 45° Street Elbow	100	0.827"	0.764"	0.014	6.5
W3321	1/2" 45° Street Elbow	100	0.906"	0.886"	0.028	12.7
W3326	5/8" 45° Street Elbow	50	1.201"	1.220"	0.038	17.2
W3330	3/4" 45° Street Elbow	50	1.398"	1.398"	0.066	30.0
W3334	7/8" 45° Street Elbow	25	1.654"	1.675"	0.099	45.0
W3344	1-1/8" 45° Street Elbow	25	1.925"	1.925"	0.179	81.0
W3350	1-3/8" 45° Street Elbow	10	2.157"	2.142"	0.254	115.0
W3355	1-5/8" 45° Street Elbow	10	2.402"	2.386"	0.351	159.0
W3359	2-1/8" 45° Street Elbow	5	2.843"	2.862"	0.619	281.0
W3363	2-5/8" 45° Street Elbow	2	3.346"	3.366"	1.080	490.0

The information contained herein is not intended to replace the full product installation and safety information available or the experience of a trained product installer. You are required to thoroughly read all installation instructions and product safety information before beginning the installation of a product.

All installations must completely comply with all NDL Industries warnings and instructions, national state and local codes and all applicable ANSI standards.

NDL Industries product specifications in U.S. customary units and metric are approximate and are provided for reference only. For precise measurements, please contact Customer

Service. NDL Industries reserves the right to change or modify product design, construction, specifications, or materials without prior notice and without incurring any obligation to make such changes and modifications on NDL products previously or subsequently sold.

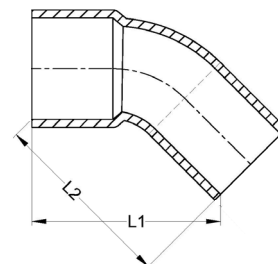

Explore our full line of high-quality HVAC-R, CO₂ Refrigeration, and Hydronic products.

ndlindustries.com | 1-866-635-6888 | sales@ndlinc.com

@ndlindustries





90° Long Radius Elbows

90° Long Radius Elbow Dimensions and Selection

PART #	OD - DESCRIPTION	BOX QTY	L1 (IN)	WT (LB)	WT (G)
W2715	1/4" 90° Long Radius Elbow (C x C)	50	0.906"	0.014	6.3
W2710	5/16" 90° Long Radius Elbow (C x C)	50	1.087"	0.022	10.0
W2716	3/8" 90° Long Radius Elbow (C x C)	50	1.319"	0.051	23.0
W2717	1/2" 90° Long Radius Elbow (C x C)	50	1.457"	0.051	23.0
W2722	5/8" 90° Long Radius Elbow (C x C)	50	1.764"	0.088	40.0
W2622	5/8" 90° Long Radius Elbow (FTG x FTG)	50	1.764"	0.088	39.9
W2728	3/4" 90° Long Radius Elbow (C x C)	50	2.177"	0.104	47.0
W2734	7/8" 90° Long Radius Elbow (C x C)	25	2.461"	0.199	90.3
W2747	1-1/8" 90° Long Radius Elbow (C x C)	10	3.071"	0.401	182.0
W2055	1-3/8" 90° Long Radius Elbow (C x C)	10	3.614"	0.417	189.0
W2650	1-3/8" 90° Long Radius Elbow (FTG x FTG)	10	3.614"	0.412	186.9
W2063	1-5/8" 90° Long Radius Elbow (C x C)	5	4.236"	0.575	261.0
W2655	1-5/8" 90° Long Radius Elbow (FTG x FTG)	5	4.236"	0.573	259.9
W2072	2-1/8" 90° Long Radius Elbow (C x C)	5	5.402"	1.174	532.3
W2659	2-1/8" 90° Long Radius Elbow (FTG x FTG)	5	5.402"	1.167	529.3
W2082	2-5/8" 90° Long Radius Elbow (C x C)	2	6.543"	1.896	860.0
W2092	3-1/8" 90° Long Radius Elbow (C x C)	EA	7.963"	3.230	1465.0
W2093	3-5/8" 90° Long Radius Elbow (C x C)	EA	8.750"	5.732	2600.0
W2095	4-1/8" 90° Long Radius Elbow (FTG x FTG)	EA	10.246"	6.812	3090.0

The information contained herein is not intended to replace the full product installation and safety information available or the experience of a trained product installer. You are required to thoroughly read all installation instructions and product safety information before beginning the installation of a product.

All installations must completely comply with all NDL Industries warnings and instructions, national state and local codes and all applicable ANSI standards.

NDL Industries product specifications in U.S. customary units and metric are approximate and are provided for reference only. For precise measurements, please contact Customer

Service. NDL Industries reserves the right to change or modify product design, construction, specifications, or materials without prior notice and without incurring any obligation to make such changes and modifications on NDL products previously or subsequently sold.

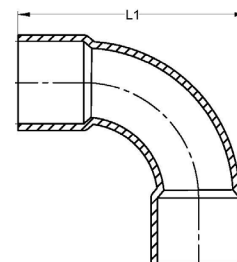

Explore our full line of high-quality HVAC-R, CO₂ Refrigeration, and Hydronic products.

ndlindustries.com | 1-866-635-6888 | sales@ndlinc.com

@ndlindustries





90° Long Radius Reducing Elbows

90° Long Radius Reducing Elbow Dimensions and Selection

	PART #	OD - DESCRIPTION	BOX QTY	L1 (IN)	L2 (IN)	WT (LB)	WT (G)
	W2723	5/8" x 1/2" 90° Long Radius Reducing Elbow	50	1.713"	1.614"	0.088	40.0
	W2749	1-1/8" x 7/8" 90° Long Radius Reducing Elbow	10	2.717"	2.539"	0.276	125.0
	W2756	1-3/8" x 1-1/8" 90° Long Radius Reducing Elbow	10	3.327"	3.110"	0.430	195.0

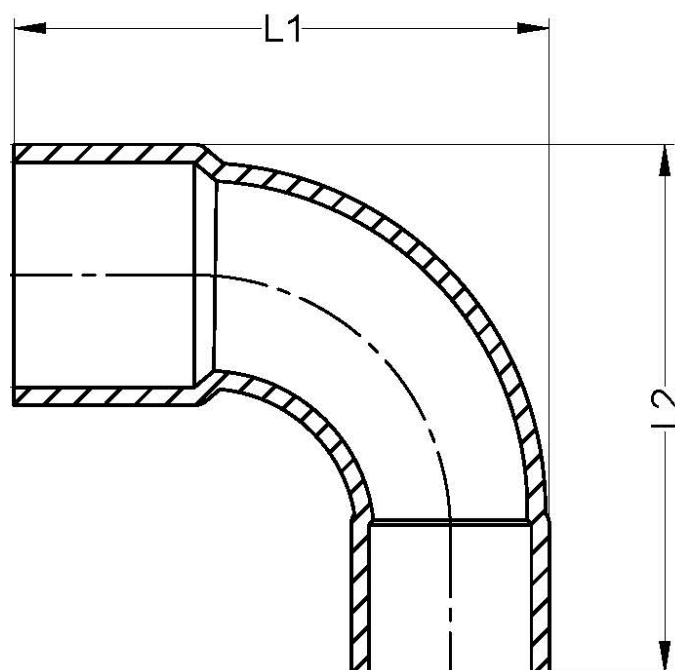

The information contained herein is not intended to replace the full product installation and safety information available or the experience of a trained product installer. You are required to thoroughly read all installation instructions and product safety information before beginning the installation of a product.

All installations must completely comply with all NDL Industries warnings and instructions, national state and local codes and all applicable ANSI standards.

NDL Industries product specifications in U.S. customary units and metric are approximate and are provided for reference only. For precise measurements, please contact Customer.

Service. NDL Industries reserves the right to change or modify product design, construction, specifications, or materials without prior notice and without incurring any obligation to make such changes and modifications on NDL products previously or subsequently sold.



Explore our full line of high-quality HVAC-R, CO₂ Refrigeration, and Hydronic products.

ndlindustries.com | 1-866-635-6888 | sales@ndlinc.com

@ndlindustries





90° Long Radius Street Elbows

90° Long Radius Street Elbow Dimensions and Selection

PART #	OD - DESCRIPTION	BOX QTY	L1 (IN)	L2 (IN)	WT (LB)	WT (G)
W2809	3/8" 90° Long Radius Street Elbow	50	1.260"	1.350"	0.043	19.4
W2817	1/2" 90° Long Radius Street Elbow	50	1.407"	1.516"	0.049	22.0
W2822	5/8" 90° Long Radius Street Elbow	50	1.654"	1.752"	0.057	26.0
W2828	3/4" 90° Long Radius Street Elbow	25	2.126"	2.220"	0.101	46.0
W2834	7/8" 90° Long Radius Street Elbow	25	2.390"	2.480"	0.196	89.0
W2847	1-1/8" 90° Long Radius Street Elbow	10	2.972"	3.071"	0.269	122.0
W2350	1-3/8" 90° Long Radius Street Elbow	10	3.543"	3.642"	0.412	187.0
W2355	1-5/8" 90° Long Radius Street Elbow	5	4.173"	4.311"	0.573	260.0
W2359	2-1/8" 90° Long Radius Street Elbow	5	5.295"	5.472"	1.167	529.2
W2363	2-5/8" 90° Long Radius Street Elbow	2	6.457"	6.594"	1.883	854.0
W2368	3-1/8" 90° Long Radius Street Elbow	EA	7.876"	7.935"	3.307	1500.0
W2393	3-5/8" 90° Long Radius Street Elbow	EA	8.642"	8.817"	5.732	2600.0
W2395	4-1/8" 90° Long Radius Street Elbow	EA	10.157"	10.297"	6.812	3090.0

The information contained herein is not intended to replace the full product installation and safety information available or the experience of a trained product installer. You are required to thoroughly read all installation instructions and product safety information before beginning the installation of a product.

All installations must completely comply with all NDL Industries warnings and instructions, national state and local codes and all applicable ANSI standards.

NDL Industries product specifications in U.S. customary units and metric are approximate and are provided for reference only. For precise measurements, please contact Customer

Service. NDL Industries reserves the right to change or modify product design, construction, specifications, or materials without prior notice and without incurring any obligation to make such changes and modifications on NDL products previously or subsequently sold.

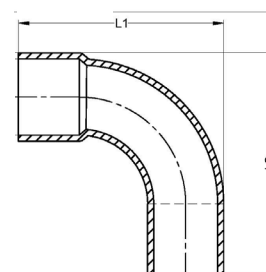

Explore our full line of high-quality HVAC-R, CO₂ Refrigeration, and Hydronic products.

ndlindustries.com | 1-866-635-6888 | sales@ndlinc.com

@ndlindustries





90° Short Radius Elbows

90° Short Radius Elbow Dimensions and Selection

PART #	OD - DESCRIPTION	BOX QTY	L1 (IN)	WT (LB)	WT (G)
W2003	1/4" 90° Short Radius Elbow	50	0.819"	0.014	6.5
W2009	3/8" 90° Short Radius Elbow	50	0.957"	0.036	16.5
W2017	1/2" 90° Short Radius Elbow	50	1.193"	0.031	14.2
W2022	5/8" 90° Short Radius Elbow	50	1.516"	0.098	44.5
W2028	3/4" 90° Short Radius Elbow	50	1.929"	0.090	41.0
W2034	7/8" 90° Short Radius Elbow	50	2.083"	0.121	55.0
W2047	1-1/8" 90° Short Radius Elbow	25	2.657"	0.238	108.0
W2084	1-3/8" 90° Short Radius Elbow	10	2.854"	0.331	150.0
W2085	1-5/8" 90° Short Radius Elbow	10	3.205"	0.463	210.0
W2086	2-1/8" 90° Short Radius Elbow	5	4.035"	0.761	345.0
W2087	2-5/8" 90° Short Radius Elbow	4	4.744"	1.323	600.0
W2088	3-1/8" 90° Short Radius Elbow	2	5.512"	1.764	800.0
W2089	3-5/8" 90° Short Radius Elbow	EA	6.280"	0.000	0.0
W2090	4-1/8" 90° Short Radius Elbow	EA	7.087"	3.792	1720.0

The information contained herein is not intended to replace the full product installation and safety information available or the experience of a trained product installer. You are required to thoroughly read all installation instructions and product safety information before beginning the installation of a product.

All installations must completely comply with all NDL Industries warnings and instructions, national state and local codes and all applicable ANSI standards.

NDL Industries product specifications in U.S. customary units and metric are approximate and are provided for reference only. For precise measurements, please contact Customer

Service. NDL Industries reserves the right to change or modify product design, construction, specifications, or materials without prior notice and without incurring any obligation to make such changes and modifications on NDL products previously or subsequently sold.

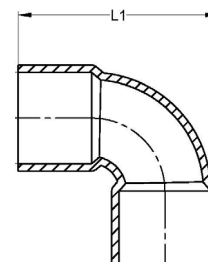

Explore our full line of high-quality HVAC-R, CO₂ Refrigeration, and Hydronic products.

ndlindustries.com | 1-866-635-6888 | sales@ndlinc.com

@ndlindustries





90° Short Radius Reducing Elbows

90° Short Radius Reducing Elbow Dimensions and Selection

	PART #	OD - DESCRIPTION	BOX QTY	L1 (IN)	L2 (IN)	WT (LB)	WT (G)
	W2011	3/8" x 1/4" 90° Short Radius Reducing Elbow	50	0.846"	0.854"	0.031	14.0
	W2036	7/8" x 5/8" 90° Short Radius Reducing Elbow	50	2.087"	1.909"	0.121	55.0

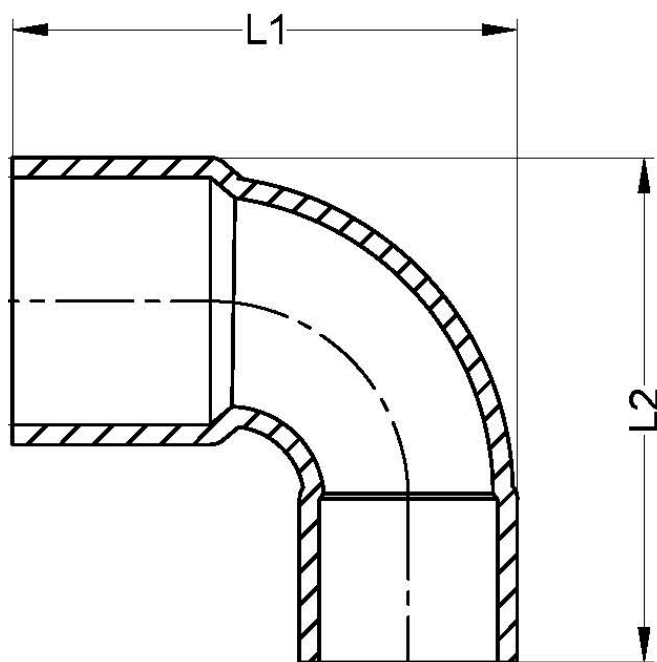

The information contained herein is not intended to replace the full product installation and safety information available or the experience of a trained product installer. You are required to thoroughly read all installation instructions and product safety information before beginning the installation of a product.

All installations must completely comply with all NDL Industries warnings and instructions, national state and local codes and all applicable ANSI standards.

NDL Industries product specifications in U.S. customary units and metric are approximate and are provided for reference only. For precise measurements, please contact Customer.

Service. NDL Industries reserves the right to change or modify product design, construction, specifications, or materials without prior notice and without incurring any obligation to make such changes and modifications on NDL products previously or subsequently sold.



Explore our full line of high-quality HVAC-R, CO₂ Refrigeration, and Hydronic products.

ndlindustries.com | 1-866-635-6888 | sales@ndlinc.com

@ndlindustries





90° Short Radius Street Elbows

90° Short Radius Street Elbow Dimensions and Selection

	PART #	OD - DESCRIPTION	BOX QTY	L1 (IN)	L2 (IN)	WT (LB)	WT (G)
	W2305	1/4" 90° Short Radius Street Elbow	50	0.780"	0.917"	0.012	5.5
	W2312	3/8" 90° Short Radius Street Elbow	50	0.890"	0.984"	0.032	14.4
	W2321	1/2" 90° Short Radius Street Elbow	50	1.150"	1.220"	0.032	14.6
	W2326	5/8" 90° Short Radius Street Elbow	50	1.425"	1.504"	0.046	21.0
	W2330	3/4" 90° Short Radius Street Elbow	25	1.831"	1.870"	0.088	40.0
	W2334	7/8" 90° Short Radius Street Elbow	25	2.008"	2.094"	0.122	55.2
	W2344	1-1/8" 90° Short Radius Street Elbow	25	2.551"	2.630"	0.231	105.0

The information contained herein is not intended to replace the full product installation and safety information available or the experience of a trained product installer. You are required to thoroughly read all installation instructions and product safety information before beginning the installation of a product.

All installations must completely comply with all NDL Industries warnings and instructions, national state and local codes and all applicable ANSI standards.

NDL Industries product specifications in U.S. customary units and metric are approximate and are provided for reference only. For precise measurements, please contact Customer

Service. NDL Industries reserves the right to change or modify product design, construction, specifications, or materials without prior notice and without incurring any obligation to make such changes and modifications on NDL products previously or subsequently sold.

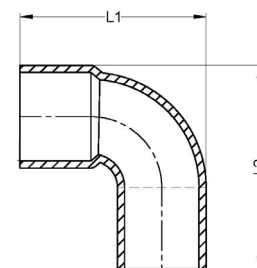

Explore our full line of high-quality HVAC-R, CO₂ Refrigeration, and Hydronic products.

ndlindustries.com | 1-866-635-6888 | sales@ndlinc.com

@ndlindustries





P-Trap Dimensions and Selection

	PART #	OD - DESCRIPTION	BOX QTY	L1 (IN)	L2 (IN)	L3 (IN)	WT (LB)	WT (G)
	W60999	5/8" P-Trap	10	7.028"	6.181"	6.563"	0.430	195.0
	W61008	3/4" P-Trap	10	7.122"	6.378"	6.693"	0.538	244.0
	W61000	7/8" P-Trap	5	7.028"	6.496"	6.929"	0.694	315.0
	W61001	1-1/8" P-Trap	3	7.323"	6.594"	6.811"	1.071	486.0
	W61002	1-3/8" P-Trap	EA	8.583"	6.909"	7.559"	1.367	620.0
	W61003	1-5/8" P-Trap	EA	10.827"	9.331"	10.368"	2.315	1050.0
	W61009	2-1/8" P-Trap	EA	11.358"	11.358"	11.929"	4.068	1845.0

The information contained herein is not intended to replace the full product installation and safety information available or the experience of a trained product installer. You are required to thoroughly read all installation instructions and product safety information before beginning the installation of a product.

All installations must completely comply with all NDL Industries warnings and instructions, national state and local codes and all applicable ANSI standards.

NDL Industries product specifications in U.S. customary units and metric are approximate and are provided for reference only. For precise measurements, please contact Customer

Service. NDL Industries reserves the right to change or modify product design, construction, specifications, or materials without prior notice and without incurring any obligation to make such changes and modifications on NDL products previously or subsequently sold.

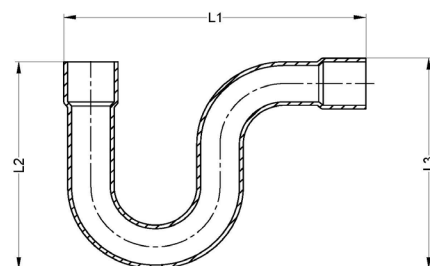

Explore our full line of high-quality HVAC-R, CO₂ Refrigeration, and Hydronic products.

ndlindustries.com | 1-866-635-6888 | sales@ndlinc.com

@ndlindustries





Return Bends

Return Bend Dimensions and Selection

PART #	OD - DESCRIPTION	BOX QTY	L1 (IN)	L2 (IN)	WT (LB)	WT (G)
W6032	1/2" x 1-1/2" Return Bend	50	2.075"	1.398"	0.057	26.0
W6051	5/8" x 1-9/16" Return Bend	25	2.264"	1.555"	0.099	45.0
W6056	5/8" x 2-1/4" Return Bend	25	2.953"	1.909"	0.106	48.0
W6058	5/8" x 2-1/2" Return Bend	25	3.213"	2.087"	0.143	65.0
W6092	7/8" x 2-1/2" Return Bend	10	3.465"	2.516"	0.220	100.0
W6095	7/8" x 3-3/8" Return Bend	10	4.339"	2.764"	0.278	126.0
W60110	1-1/8" x 3" Return Bend	5	4.228"	2.925"	0.412	187.0
W60121	1-3/8" x 3-3/4" Return Bend	4	5.256"	3.484"	0.617	280.0
W60131	1-5/8" x 4-1/2" Return Bend	5	6.205"	4.252"	0.908	412.0
W60140	2-1/8" x 5-1/2" Return Bend	2	7.752"	4.862"	1.764	800.0

The information contained herein is not intended to replace the full product installation and safety information available or the experience of a trained product installer. You are required to thoroughly read all installation instructions and product safety information before beginning the installation of a product.

All installations must completely comply with all NDL Industries warnings and instructions, national state and local codes and all applicable ANSI standards.

NDL Industries product specifications in U.S. customary units and metric are approximate and are provided for reference only. For precise measurements, please contact Customer

Service. NDL Industries reserves the right to change or modify product design, construction, specifications, or materials without prior notice and without incurring any obligation to make such changes and modifications on NDL products previously or subsequently sold.

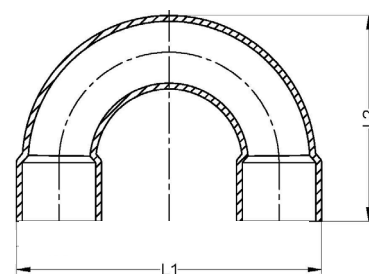

Explore our full line of high-quality HVAC-R, CO₂ Refrigeration, and Hydronic products.

ndlindustries.com | 1-866-635-6888 | sales@ndlinc.com

@ndlindustries





Tee Dimensions and Selection

PART #	OD - DESCRIPTION	BOX QTY	L1 (IN)	L2 (IN)	WT (LB)	WT (G)
W40306	1/4" Tee	100	0.976"	0.634"	0.016	7.1
W40313	5/16" Tee	50	1.161"	0.76"	0.028	12.5
W4000	3/8" Tee	50	1.083"	0.858"	0.031	14
W4001	1/2" Tee	50	1.291"	1.094"	0.042	19
W4006	5/8" Tee	50	1.705"	1.319"	0.077	35
W4017	3/4" Tee	25	2.067"	1.559"	0.138	62.5
W4031	7/8" Tee	25	2.48"	1.839"	0.198	90
W4048	1-1/8" Tee	10	3.071"	2.224"	0.342	155
W4068	1-3/8" Tee	5	3.406"	2.598"	0.496	225
W4084	1-5/8" Tee	5	3.937"	3.012"	0.747	339
W40102	2-1/8" Tee	5	4.892"	3.799"	1.698	770
W40123	2-5/8" Tee	2	5.797"	4.636"	2.26	1025
W40152	3-1/8" Tee	2	6.683"	5.197"	3.307	1500
W40200	4-1/8" Tee	EA	8.711"	6.713"	5.247	2380

The information contained herein is not intended to replace the full product installation and safety information available or the experience of a trained product installer. You are required to thoroughly read all installation instructions and product safety information before beginning the installation of a product.

All installations must completely comply with all NDL Industries warnings and instructions, national state and local codes and all applicable ANSI standards.

NDL Industries product specifications in U.S. customary units and metric are approximate and are provided for reference only. For precise measurements, please contact Customer

Service. NDL Industries reserves the right to change or modify product design, construction, specifications, or materials without prior notice and without incurring any obligation to make such changes and modifications on NDL products previously or subsequently sold.

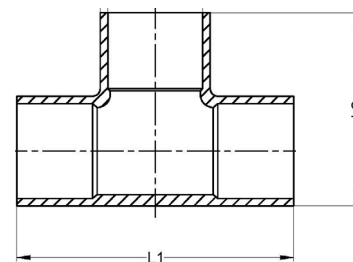

Explore our full line of high-quality HVAC-R, CO₂ Refrigeration, and Hydronic products.

ndlindustries.com | 1-866-635-6888 | sales@ndlinc.com

@ndlindustries





Reducing Tees

Reducing Tee Dimensions and Selection

PART #	OD - DESCRIPTION	BOX QTY	L1 (IN)	L2 (IN)	WT (LB)	WT (G)
W40324	3/8" x 3/8" x 1/4" Reducing Tee	50	1.201"	0.748"	0.031	14.0
W40350	1/2" x 1/2" x 1/4" Reducing Tee	50	1.220"	0.945"	0.040	18.0
W4002	1/2" x 1/2" x 3/8" Reducing Tee	50	1.224"	0.937"	0.041	18.5
W4014	5/8" x 5/8" x 1/4" Reducing Tee	50	1.457"	1.043"	0.062	28.0
W4008	5/8" x 5/8" x 3/8" Reducing Tee	50	1.461"	1.075"	0.071	32.0
W4007	5/8" x 5/8" x 1/2" Reducing Tee	50	1.626"	1.220"	0.073	33.0
W4020	3/4" x 3/4" x 3/8" Reducing Tee	25	1.732"	1.240"	0.099	45.0
W4019	3/4" x 3/4" x 1/2" Reducing Tee	25	2.008"	1.295"	0.129	58.5
W4034	7/8" x 7/8" x 1/2" Reducing Tee	25	2.098"	1.437"	0.143	65.0
W4035	7/8" x 7/8" x 3/8" Reducing Tee	25	2.126"	1.354"	0.143	65.0
W4033	7/8" x 7/8" x 5/8" Reducing Tee	25	2.213"	1.587"	0.144	65.5
W4051	1-1/8" x 1-1/8" x 5/8" Reducing Tee	10	2.657"	1.807"	0.209	95.0
W4052	1-1/8" x 1-1/8" x 1/2" Reducing Tee	10	2.677"	1.693"	0.209	95.0
W4050	1-1/8" x 1-1/8" x 3/4" Reducing Tee	10	2.654"	1.925"	0.249	113.0
W4049	1-1/8" x 1-1/8" x 7/8" Reducing Tee	10	2.815"	2.087"	0.265	120.0
W4072	1-3/8" x 1-3/8" x 1/2" Reducing Tee	EA	2.776"	2.028"	0.287	130.0
W4071	1-3/8" x 1-3/8" x 5/8" Reducing Tee	5	2.717"	2.106"	0.342	155.0
W4088	1-5/8" x 1-5/8" x 5/8" Reducing Tee	5	2.933"	2.362"	0.381	173.0
W4070	1-3/8" x 1-3/8" x 7/8" Reducing Tee	5	2.953"	2.343"	0.408	185.0
W4069	1-3/8" x 1-3/8" x 1-1/8" Reducing Tee	5	3.228"	2.539"	0.419	190.0
W4089	1-5/8" x 1-5/8" x 1/2" Reducing Tee	5	2.913"	2.244"	0.578	262.0
W4087	1-5/8" x 1-5/8" x 7/8" Reducing Tee	5	3.209"	2.638"	0.595	270.0
W4086	1-5/8" x 1-5/8" x 1-1/8" Reducing Tee	5	3.465"	2.776"	0.617	280.0
W40107	2-1/8" x 2-1/8" x 5/8" Reducing Tee	5	3.543"	2.874"	0.668	303.0
W40108	2-1/8" x 2-1/8" x 1/2" Reducing Tee	2	3.465"	2.894"	0.679	308.0
W4085	1-5/8" x 1-5/8" x 1-3/8" Reducing Tee	5	3.720"	2.846"	0.688	312.0

The information contained herein is not intended to replace the full product installation and safety information available or the experience of a trained product installer. You are required to thoroughly read all installation instructions and product safety information before beginning the installation of a product.

All installations must completely comply with all NDL Industries warnings and instructions, national state and local codes and all applicable ANSI standards.

NDL Industries product specifications in U.S. customary units and metric are approximate and are provided for reference only. For precise measurements, please contact Customer

Service. NDL Industries reserves the right to change or modify product design, construction, specifications, or materials without prior notice and without incurring any obligation to make such changes and modifications on NDL products previously or subsequently sold.

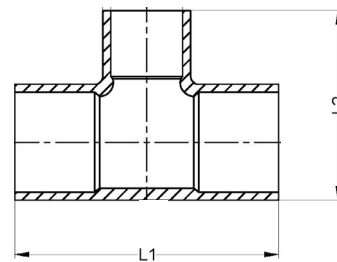

Explore our full line of high-quality HVAC-R, CO₂ Refrigeration, and Hydronic products.

ndlindustries.com | 1-866-635-6888 | sales@ndlinc.com

@ndlindustries





Reducing Tees - Continued

Reducing Tee Dimensions and Selection

PART #	OD - DESCRIPTION	BOX QTY	L1 (IN)	L2 (IN)	WT (LB)	WT (G)
W40106	2-1/8" x 2-1/8" x 7/8" Reducing Tee	5	3.780"	3.083"	0.765	347.0
W40105	2-1/8" x 2-1/8" x 1-1/8" Reducing Tee	5	3.959"	3.386"	0.937	425.0
W40104	2-1/8" x 2-1/8" x 1-3/8" Reducing Tee	5	4.207"	3.425"	1.146	520.0
W40103	2-1/8" x 2-1/8" x 1-5/8" Reducing Tee	5	4.459"	3.504"	1.290	585.0
W40124	2-5/8" x 2-5/8" x 2-1/8" Reducing Tee	2	5.325"	4.530"	1.510	685.0
W40125	2-5/8" x 2-5/8" x 1-5/8" Reducing Tee	2	4.744"	4.035"	1.874	850.0
W40127	2-5/8" x 2-5/8" x 1-1/8" Reducing Tee	2	4.400"	3.917"	1.909	866.0
W40129	2-5/8" x 2-5/8" x 5/8" Reducing Tee	2	3.927"	3.622"	1.909	866.0
W40150	3-1/8" x 3-1/8" x 2-1/8" Reducing Tee	2	5.846"	4.843"	2.275	1032.0
W40149	3-1/8" x 3-1/8" x 1-5/8" Reducing Tee	2	5.089"	4.646"	2.381	1080.0
W40148	3-1/8" x 3-1/8" x 1-3/8" Reducing Tee	2	4.911"	4.649"	2.383	1081.0

The information contained herein is not intended to replace the full product installation and safety information available or the experience of a trained product installer. You are required to thoroughly read all installation instructions and product safety information before beginning the installation of a product.

All installations must completely comply with all NDL Industries warnings and instructions, national state and local codes and all applicable ANSI standards.

NDL Industries product specifications in U.S. customary units and metric are approximate and are provided for reference only. For precise measurements, please contact Customer

Service. NDL Industries reserves the right to change or modify product design, construction, specifications, or materials without prior notice and without incurring any obligation to make such changes and modifications on NDL products previously or subsequently sold.

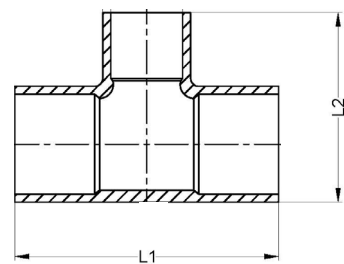

Explore our full line of high-quality HVAC-R, CO₂ Refrigeration, and Hydronic products.

ndlindustries.com | 1-866-635-6888 | sales@ndlinc.com

@ndlindustries





Reducing Tees

Reducing Tee Dimensions and Selection

PART #	OD - DESCRIPTION	BOX QTY	L1 (IN)	L2 (IN)	WT (LB)	WT (G)
W40330	3/8" x 1/4" x 3/8" Reducing Tee	50	1.337"	0.827"	0.028	12.5
W4003	1/2" x 3/8" x 1/2" Reducing Tee	EA	1.575"	1.063"	0.049	22.0
W4009	5/8" x 1/2" x 5/8" Reducing Tee	50	1.846"	1.291"	0.077	35.0
W4012	5/8" x 3/8" x 5/8" Reducing Tee	50	1.949"	1.319"	0.088	40.0
W4041	7/8" x 5/8" x 7/8" Reducing Tee	25	2.697"	1.791"	0.176	80.0
W4055	1-1/8" x 7/8" x 1-1/8" Reducing Tee	10	3.130"	2.224"	0.331	150.0
W4061	1-1/8" x 5/8" x 1-1/8" Reducing Tee	10	3.297"	2.224"	0.337	153.0
W4078	1-3/8" x 7/8" x 1-3/8" Reducing Tee	5	3.976"	2.559"	0.529	240.0
W4090	1-5/8" x 1-3/8" x 1-5/8" Reducing Tee	EA	4.193"	2.898"	0.769	349.0
W4095	1-5/8" x 1-1/8" x 1-5/8" Reducing Tee	5	4.453"	2.972"	0.774	351.0
W4099	1-5/8" x 7/8" x 1-5/8" Reducing Tee	5	4.488"	2.913"	0.783	355.0
W40109	2-1/8" x 1-5/8" x 2-1/8" Reducing Tee	2	5.478"	3.762"	1.590	721.0
W40115	2-1/8" x 1-3/8" x 2-1/8" Reducing Tee	EA	5.652"	3.762"	1.874	850.0

The information contained herein is not intended to replace the full product installation and safety information available or the experience of a trained product installer. You are required to thoroughly read all installation instructions and product safety information before beginning the installation of a product.

All installations must completely comply with all NDL Industries warnings and instructions, national state and local codes and all applicable ANSI standards.

NDL Industries product specifications in U.S. customary units and metric are approximate and are provided for reference only. For precise measurements, please contact Customer

Service. NDL Industries reserves the right to change or modify product design, construction, specifications, or materials without prior notice and without incurring any obligation to make such changes and modifications on NDL products previously or subsequently sold.

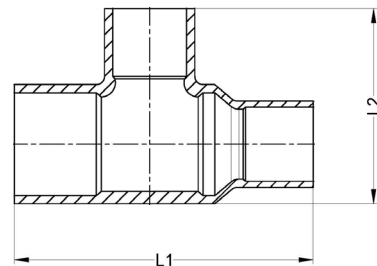

Explore our full line of high-quality HVAC-R, CO₂ Refrigeration, and Hydronic products.

ndlindustries.com | 1-866-635-6888 | sales@ndlinc.com

@ndlindustries





Reducing Tees

Reducing Tee Dimensions and Selection

PART #	OD - DESCRIPTION	BOX QTY	L1 (IN)	L2 (IN)	WT (LB)	WT (G)
W4004	1/2" x 3/8" x 3/8" Reducing Tee	50	1.496"	0.984"	0.049	22.0
W4010	5/8" x 1/2" x 1/2" Reducing Tee	50	1.744"	1.209"	0.068	31.0
W4011	5/8" x 1/2" x 3/8" Reducing Tee	50	1.673"	1.043"	0.077	35.0
W4037	7/8" x 3/4" x 3/4" Reducing Tee	25	2.618"	1.654"	0.165	75.0
W4045	7/8" x 5/8" x 3/8" Reducing Tee	25	2.173"	1.409"	0.165	75.0
W4043	7/8" x 5/8" x 5/8" Reducing Tee	25	2.382"	1.555"	0.187	85.0
W4044	7/8" x 5/8" x 1/2" Reducing Tee	25	2.323"	1.417"	0.187	85.0
W4056	1-1/8" x 7/8" x 7/8" Reducing Tee	10	3.122"	2.067"	0.287	130.0
W4076	1-3/8" x 1-1/8" x 5/8" Reducing Tee	5	3.118"	2.114"	0.330	149.9
W4080	1-3/8" x 7/8" x 7/8" Reducing Tee	5	3.366"	2.335"	0.441	200.0
W4075	1-3/8" x 1-1/8" x 7/8" Reducing Tee	5	3.346"	2.343"	0.441	200.0
W4074	1-3/8" x 1-1/8" x 1-1/8" Reducing Tee	5	3.760"	2.520"	0.485	220.0
W4079	1-3/8" x 7/8" x 1-1/8" Reducing Tee	EA	3.504"	2.480"	0.549	249.0
W4093	1-5/8" x 1-3/8" x 7/8" Reducing Tee	5	3.681"	2.657"	0.661	300.0
W4092	1-5/8" x 1-3/8" x 1-1/8" Reducing Tee	5	3.957"	2.756"	0.692	314.0
W4091	1-5/8" x 1-3/8" x 1-3/8" Reducing Tee	5	4.276"	2.835"	0.723	328.0
W40110	2-1/8" x 1-5/8" x 1-5/8" Reducing Tee	2	5.041"	3.583"	1.323	600.0
W40131	2-5/8" x 2-1/8" x 2-1/8" Reducing Tee	2	5.986"	4.451"	1.836	833.0

The information contained herein is not intended to replace the full product installation and safety information available or the experience of a trained product installer. You are required to thoroughly read all installation instructions and product safety information before beginning the installation of a product.

All installations must completely comply with all NDL Industries warnings and instructions, national state and local codes and all applicable ANSI standards.

NDL Industries product specifications in U.S. customary units and metric are approximate and are provided for reference only. For precise measurements, please contact Customer

Service. NDL Industries reserves the right to change or modify product design, construction, specifications, or materials without prior notice and without incurring any obligation to make such changes and modifications on NDL products previously or subsequently sold.

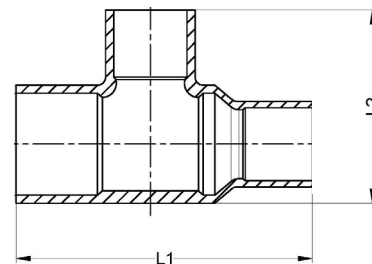

Explore our full line of high-quality
HVAC-R, CO₂ Refrigeration, and Hydronic products.

ndlindustries.com | 1-866-635-6888 | sales@ndlinc.com

@ndlindustries





Reducing Tees

Reducing Tee Dimensions and Selection

	PART #	OD - DESCRIPTION	BOX QTY	L1 (IN)	L2 (IN)	WT (LB)	WT (G)
	W40368	1/4" x 1/4" x 3/8" Reducing Tee	50	1.437"	0.815"	0.035	16
	W4005	3/8" x 3/8" x 1/2" Reducing Tee	50	1.969"	1.043"	0.053	24
	W4015	1/2" x 1/2" x 5/8" Reducing Tee	50	1.496"	1.181"	0.066	30
	W4016	3/8" x 3/8" x 5/8" Reducing Tee	50	2.087"	1.339"	0.088	40
	W4065	7/8" x 7/8" x 1-1/8" Reducing Tee	10	2.835"	2.087"	0.309	140
	W40100	1-3/8" x 1-3/8" x 1-5/8" Reducing Tee	5	3.701"	2.894"	0.727	329.7
	W40121	1-5/8" x 1-5/8" x 2-1/8" Reducing Tee	5	5.531"	3.703"	1.542	699.4

The information contained herein is not intended to replace the full product installation and safety information available or the experience of a trained product installer. You are required to thoroughly read all installation instructions and product safety information before beginning the installation of a product.

All installations must completely comply with all NDL Industries warnings and instructions, national state and local codes and all applicable ANSI standards.

NDL Industries product specifications in U.S. customary units and metric are approximate and are provided for reference only. For precise measurements, please contact Customer

Service. NDL Industries reserves the right to change or modify product design, construction, specifications, or materials without prior notice and without incurring any obligation to make such changes and modifications on NDL products previously or subsequently sold.

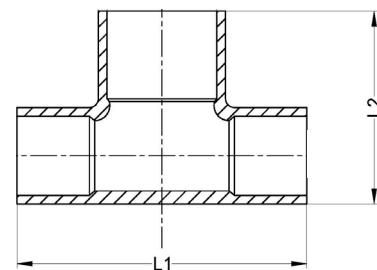

Explore our full line of high-quality HVAC-R, CO₂ Refrigeration, and Hydronic products.

ndlindustries.com | 1-866-635-6888 | sales@ndlinc.com

@ndlindustries



Union Dimensions and Selection

	PART #	OD - DESCRIPTION	BOX QTY	L1 (IN)	WT (LB)	WT (G)
	W8003	5/8" Union	25	1.378"	0.143	65.0
	W8004	7/8" Union	25	1.831"	0.298	135.0
	W8005	1-1/8" Union	10	2.323"	0.514	233.0
	A11206	1-5/8" Union	5	2.598"	0.661	300.0
	A11205	1-3/8" Union	10	2.323"	0.772	350.0
	A11207	2-1/8" Union	5	3.169"	0.882	400.0

The information contained herein is not intended to replace the full product installation and safety information available or the experience of a trained product installer. You are required to thoroughly read all installation instructions and product safety information before beginning the installation of a product.

All installations must completely comply with all NDL Industries warnings and instructions, national state and local codes and all applicable ANSI standards.

NDL Industries product specifications in U.S. customary units and metric are approximate and are provided for reference only. For precise measurements, please contact Customer

Service. NDL Industries reserves the right to change or modify product design, construction, specifications, or materials without prior notice and without incurring any obligation to make such changes and modifications on NDL products previously or subsequently sold.

